

INSTRUCTION MANUAL

MULTI RANGE DC POWER SUPPLY PHU SERIES

PHU-502L80	PHU-103L80	PHU-153L80
PHU-502L200	PHU-103L200	PHU-153L200
PHU-502M500	PHU-103M500	PHU-153M500
PHU-502M750	PHU-103M750	PHU-153M750
PHU-502H1000	PHU-103H1000	PHU-153H1000
PHU-502H1500	PHU-103H1500	PHU-153H1500

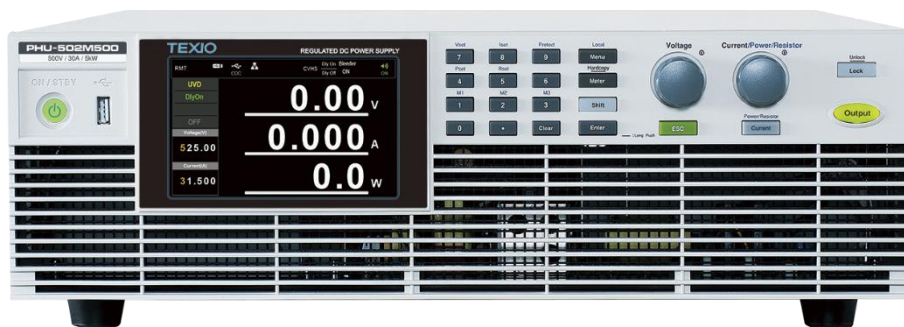

■ About Brands and Trademarks

“TEXIO” is the product brand name of our industrial electronic devices.

All company names and product names mentioned in this manual are the trademark or the registered trademark of each company or group in each country and region.

■ About the Instruction Manual

The latest version of the instruction manual is posted on our website (<https://www.texio.co.jp/>)

In order to be environmentally friendly and reduce waste, we are gradually discontinuing the use of paper or CD manuals that come with our products.

Even if there is a description in the instruction manual that the product is included, it may not be included.

■ About firmware version

This user manual is required firmware version 1.47 or higher.

Table of Contents

USING THE PRODUCT SAFELY ...I

1.	GETTING STARTED	1
1-1.	PHU Series Overview	1
1-1-1.	Series lineup.....	1
1-1-2.	Main Features	2
1-1-3.	Accessories	3
1-2.	Appearance	5
1-2-1.	Front Panel.....	5
1-2-2.	PHU Series Display and Operation Panel.....	7
1-2-3.	Rear Panel	9
1-3.	Theory of Operation.....	11
1-3-1.	Operating Area Description	11
1-3-2.	CC and CV Mode	14
1-3-3.	Slew Rate	15
1-3-4.	Bleeder Control	15
1-3-5.	Internal Resistance	16
1-3-6.	Alarms	17
1-3-7.	Considerations	18
1-3-8.	Grounding.....	20
2.	OPERATION.....	21
2-1.	Set Up	21
2-1-1.	Line Voltage Connection.....	21
2-1-2.	Power Up.....	25
2-1-3.	Wire Gauge Considerations	26
2-1-4.	Output Terminals	27
2-1-5.	Using the Output Terminal Cover	28

2-1-6. Using the Rack Mount Kit	29
2-1-7. How to Use the Instrument	30
2-1-8. Reset to Factory Default Settings	33
2-1-9. View System Version and Build Date	35
2-2. Basic Operation	37
2-2-1. Setting OVP/OCP/OPP	37
2-2-2. OVP, OCP and OPP Setting Range	39
2-2-3. Delay Setting Range.....	39
2-2-4. Setting UVL/OVL/UCL/OCL/OPL/ORL.....	40
2-2-5. Setting Range.....	42
2-2-6. Setting Bleeder Control.....	43
2-2-7. Setting Output Mode.....	44
2-2-8. Setting Slew Rate Range.....	46
2-2-9. Panel Lock.....	47
2-2-10. Save (memory) Setup.....	47
2-2-11. Load (memory) Setup	48
2-2-12. Voltage Sense	49
2-3. Parallel Operation.....	53
2-3-1. Master-Slave Parallel Overview	53
2-3-2. Parallel Connection.....	56
2-3-3. Parallel Operation	56
2-4. Sequence(Test Scripts).....	59
2-4-1. Sequence File Format.....	59
2-4-2. Sequence Settings.....	59
2-4-3. Import Sequence from USB	60
2-4-4. Run Sequence	63
2-4-5. Export Sequence to USB	64
2-4-6. Delete Sequence	65
2-4-7. Edit Sequence	66
3. CONFIGURATION.....	71
3-1. Menu Overview.....	71
3-2. Menu Table.....	74

3-3.	Additional information	84
4.	Digital I/O Configuration	85
5.	ANALOG CONTROL	89
5-1.	Analog Remote Control Overview	89
5-1-1.	Analog Control Connector Overview	89
5-1-2.	External Voltage Control of Voltage Output.....	93
5-1-3.	External Voltage Control of Current Output.....	95
5-1-4.	External Voltage Control of Power Output.....	98
5-1-5.	External Voltage Control of Internal Resistance	101
5-1-6.	External Resistance Control of Voltage Output	104
5-1-7.	External Resistance Control of Current Output	107
5-1-8.	External Resistance Control of Power Output	110
5-1-9.	External Resistance Control of Internal Resistance Output.....	113
5-1-10.	External Voltage Control of Output	116
5-1-11.	External voltage control of Alarm input	120
5-2.	Remote Monitoring	122
5-2-1.	External Voltage, Current and Power Monitoring	122
5-2-2.	External Operation and Status Monitoring.....	124
6.	COMMUNICATION INTERFACE	126
6-1.	USB Remote Interface	126
6-1-1.	USB Configuration.....	126
6-1-2.	USB Function Check	127
6-2.	GPIB Remote Interface (optional)	128
6-2-1.	GP-IB Configuration	128
6-2-2.	GP-IB Function Check.....	129
6-3.	RS232/485 Remote Interface (optional)	132
6-3-1.	Configure RS232/485.....	132

6-3-2. RS-232C/485 Function Check	134
6-3-3. RS232/RS485 Multiple Unit Connection (Legacy mode)	135
6-3-4. RS232/485 Multiple units Function Check	137
6-4. Configure Ethernet Connection	138
6-4-1. Web Server Configuration	138
6-4-2. WEB Server Remote Control Function Check	139
6-4-3. Sockets Server Configuration	140
6-4-4. Socket Server Function Check	140
7. FAQ	144
8. APPENDIX.....	145
8-1. PHU Factory Default Settings	145
8-2. Messages.....	147
8-3. PHU Specifications.....	155
8-3-1. Output	155
8-3-2. Constant Voltage Mode	156
8-3-3. Constant Current Mode	158
8-3-4. Protection Function.....	160
8-3-5. Other Function.....	163
8-3-6. Front Panel.....	164
8-3-7. Programming and Measurement (Digital Interface)	166
8-3-8. Input Characteristics for PHU-B series (for 5kW models).....	169
8-3-9. Input Characteristics for PHU-B series (for 10kW models).....	169
8-3-10. Input Characteristics for PHU-C series (for 5kW models).....	170
8-3-11. Input Characteristics for PHU-C series (for 10kW models).....	170
8-3-12. Input Characteristics for PHU-C series (for 15kW models).....	171

8-3-13. Input Characteristics for PHU-D series (for 5kW models).....	171
8-3-14. Input Characteristics for PHU-D series (for 10kW models).....	172
8-3-15. Input Characteristics for PHU-D series (for 15kW models).....	172
8-3-16. Interface Capabilities	173
8-3-17. Isolated Analog Control Interface.....	173
8-3-18. Environment Conditions.....	174
8-3-19. General Specifications.....	175
8-4. PHU Dimensions	176
8-4-1. PHU-M,H	176
8-4-2. PHU-L.....	177



USING THE PRODUCT SAFELY

■ Preface

To use the product safely, read instruction manual to the end. Before using this product, understand how to correctly use it. If you read the manuals but you do not understand how to use it, ask us or your local dealer. After you read the manuals, save it so that you can read it anytime as required.

■ Pictorial indication

The manuals and product show the warning and caution items required to safely use the product. The following pictorial indication is provided.

Pictorial indication	
	Some part of this product or the manuals may show this pictorial indication. In this case, if the product is incorrectly used in that part, a serious danger may be brought about on the user's body or the product. To use the part with this pictorial indication, be sure to refer to the manuals.
 	If you use the product, ignoring this indication, you may get killed or seriously injured. This indication shows that the warning item to avoid the danger is provided. If you incorrectly use the product, ignoring this indication, you may get slightly injured or the product may be damaged. This indication shows that the caution item to avoid the danger is provided.

Please be informed that we are not responsible for any damages to the user or to the third person, arising from malfunctions or other failures due to wrong use of the product or incorrect operation, except such responsibility for damages as required by law.

USING THE PRODUCT SAFELY



■ Do not remove the product's covers and panels

Never remove the product's covers and panels for any purpose.
Otherwise, the user's electric shock or fire may be incurred.

■ Warning on using the product

Warning items given below are to avoid danger to user's body and life and avoid the damage or deterioration of the product. Use the product, observing the following warning and caution items.

■ Warning items on power supply

● Power supply voltage

The rated power supply voltage of the product is Type B:single phase and AC200V to AC240V (Excluding the 15kW model),three phase, and the line voltage is TypeC:AC200V to AC240V or TypeD:380V to 480V.

● Power cord

(IMPORTANT) This product does not include a power cord. Please prepare an optional power cord or a power cord that matches the rated power.

● Protective fuse

If an input protective fuse is blown, the product does not operate. For a product with external fuse holder, the fuse may be replaced. As for how to replace the fuse, refer to the corresponding chapter in the instruction manual. If no fuse replacement procedures are indicated, the user is not permitted to replace it. In such case, keep the case closed and consult us or your local dealer. If the fuse is incorrectly replaced, a fire may occur.

USING THE PRODUCT SAFELY

■ ■ Warning item on Grounding

If the product has the GND terminal on the front or rear panel surface, be sure to ground the product to safely use it.

■ Warnings on Installation environment

● Operating temperature and humidity

Use the product within the operating temperature indicated in the “rating” temperature column. If the product is used with the vents of the product blocked or in high ambient temperatures, a fire may occur. Use the product within the operating humidity indicated in the “rating” humidity column. Watch out for condensation by a sharp humidity change such as transfer to a room with a different humidity. Also, do not operate the product with wet hands. Otherwise, an electric shock or fire may occur.

● Use in gas

Use in and around a place where an inflammable or explosive gas or steam is generated or stored may result in an explosion and fire. Do not operate the product in such an environment. Also, use in and around a place where a corrosive gas is generated or spreading causes a serious damage to the product. Do not operate the product in such an environment.

● Installation place

Use indoors. Do not place on an inclined surface or in a place subject to vibration. The product may fall or tip over, resulting in damage or injury.

■ Do not let foreign matter in

Do not insert metal and inflammable materials into the product from its vent and spill water on it. Otherwise, electric shock or fire may occur.

■ Warning item on abnormality while in use

If smoke or fire is generated from the product while in use, stop using the product, turn off the switch, and remove the power cord plug from the outlet. After confirming that no other devices catch fire, ask us or your local dealer.

USING THE PRODUCT SAFELY

■ Input / Output terminals

Maximum input to terminal is specified to prevent the product from being damaged. Do not supply input, exceeding the specifications that are indicated in the "Rating" column in the instruction manual of the product. Also, do not supply power to the output terminals from the outside. Otherwise, a product failure is caused.

■ Calibration

Although the performance and specifications of the product are checked under strict quality control during shipment from the factory, they may be deviated more or less by deterioration of parts due to their aging or others.

It is recommended to periodically calibrate the product so that it is used with its performance and specifications stable. For consultation about the product calibration, ask us or your local dealer.

■ Daily Maintenance

When you clean off the dirt of the product covers, panels, and knobs, avoid solvents such as thinner and benzene. Otherwise, the paint may peel off or resin surface may be affected. To wipe off the covers, panels, and knobs, use a soft cloth with neutral detergent in it.

During cleaning, be careful that water, detergents, or other foreign matters do not get into the product.

If a liquid or metal gets into the product, an electric shock and fire are caused.

During cleaning, remove the power cord plug from the outlet.

Use the product correctly and safely, observing the above warning and caution items. Because the instruction manual indicates caution items even in individual items, observe those caution items to correctly use the product.

If you have questions or comments about the manuals, ask us or E-Mail us.

1. GETTING STARTED

This chapter describes the power supply in a nutshell, including its main features and front / rear panel introduction. After going through the overview, please read the theory of operation to become familiar with the operating modes, protection modes and other safety considerations.

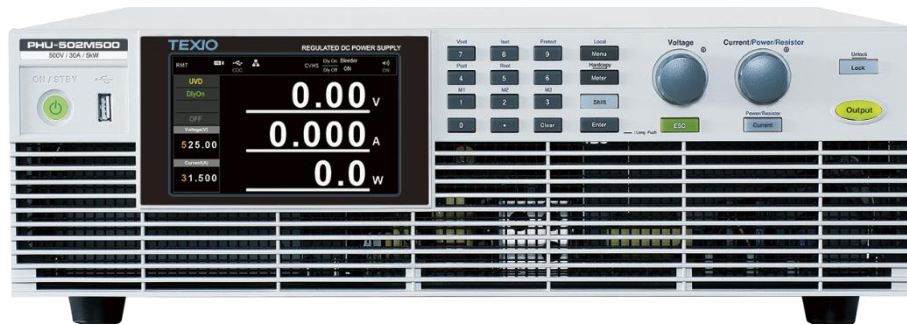

1-1. PHU Series Overview

1-1-1. Series lineup

The PHU series consists of 18 models, covering a number of different current, voltage and power capacities:

Model name	Voltage Rating ¹	Current Rating ²	Power
PHU-502L80	80 V	170 A	5000 W
PHU-103L80	80 V	340 A	10000 W
PHU-153L80	80 V	510 A	15000 W
PHU-502L200	200 V	70 A	5000 W
PHU-103L200	200 V	140 A	10000 W
PHU-153L200	200 V	210 A	15000 W
PHU-502M500	500 V	30 A	5000 W
PHU-103M500	500 V	60 A	10000 W
PHU-153M500	500 V	90 A	15000 W
PHU-502M750	750 V	20 A	5000 W
PHU-103M750	750 V	40 A	10000 W

PHU-153M750	750 V	60 A	15000 W
PHU-502H1000	1000 V	15 A	5000 W
PHU-103H1000	1000 V	30 A	10000 W
PHU-153H1000	1000 V	45 A	15000 W
PHU-502H1500	1500 V	10 A	5000 W
PHU-103H1500	1500 V	20 A	10000 W
PHU-153H1500	1500 V	30 A	15000 W

¹ Minimum voltage guaranteed to 0.2% of rating voltage.

² Minimum current guaranteed to 0.4% of rating current.



1-1-2. Main Features

Performance	<ul style="list-style-type: none"> ● High power density: 15000W in 3U ● Universal input voltage Single Phase (180 to 265) Vac (B Series) Three Phase (180 to 265) Vac (C Series), Three Phase (342 to 528) Vac (D Series) continuous operation. ● Output voltage up to 1500V, current up to 510A.
Features	<ul style="list-style-type: none"> ● Active power factor correction. ● Parallel master/slave operation with active current sharing. ● Remote sensing to compensate for voltage drop in load leads. ● 19" rack mounted ATE applications. ● A built-in Web server. ● OVP, OCP, OPP, UVL, and PUF protection. ● Preset memory function. ● Adjustable voltage and current slew rates. ● Bleeder circuit ON/OFF setting. ● CV, CC priority start function. (Prevents overshoot with output ON) ● Supports test scripts.
Interface	<ul style="list-style-type: none"> ● Built-in LAN and USB interface. ● Isolated analog control programming and monitoring interface. ● Optional interfaces: RS-232&485, GPIB.

1-1-3. Accessories

Before using the PHU power supply unit, check the package contents to make sure all the standard accessories are included.

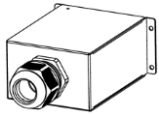
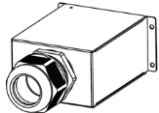
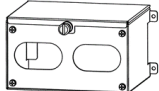
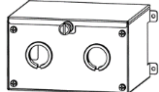
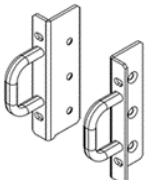
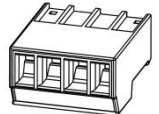
Standard Accessories

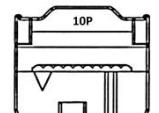
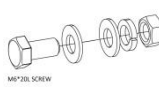

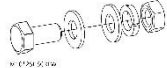
Part number	Description	Qty.	
62HU-1K0SCE01 5302-02516001 57IL-28F29301	AC INPUT terminal cover (1P-200V,5kW) (3P-200V, 5kW) (3P-400V, 5kW/10kW/15kW)	1	
62HU-1K0SCF501 5302-04030001 57IL-28F29301	ACINPUT terminal cover (1P-200V,10kW) (3P-200V, 10kW/15kW)	1	
62HU-1K0SC401 62HU-1K0SC101 62HU-1K0SC201	DCOUTPUT terminal cover (PHU-80V, PHU-200V)	1	
62HU-1K0SC301 62HU-1K0SC101 62HU-1K0SC201	DCOUTPUT terminal cover (PHU-500V, PHU-750V) (PHU-1000V, PHU-1500V)	1	
62RA-423HD101	3U Handle	2	
62RA-453HP1A1	3U Bracket (Left)	1	
62RA-453HP2A1	3U Bracket (Right)	1	
39BT-50401701	SENSING connector	1	
62HU-1K0SCD01	SENSING connector cover	1	
39BT-50800601	Digital I/O control connector	1	
40LE-010SH021	Parallel control dummy connector	1	
596M-10025NS1 6001-FN0100S1 61PF-103220N1 61SF-103170N1	DC OUTPUT terminal screws (PHU-80V, PHU-200V)	1	

596M-W6020NS1	DC OUTPUT terminal screws (PHU-500V, PHU-750V) (PHU-1000V, PHU-1500V)	1	
---------------	---	---	---

Factory Options

Part number	Description
PHU+VG	GPIB interface
PHU+VR	RS-232&RS-485 interface card (RJ45)







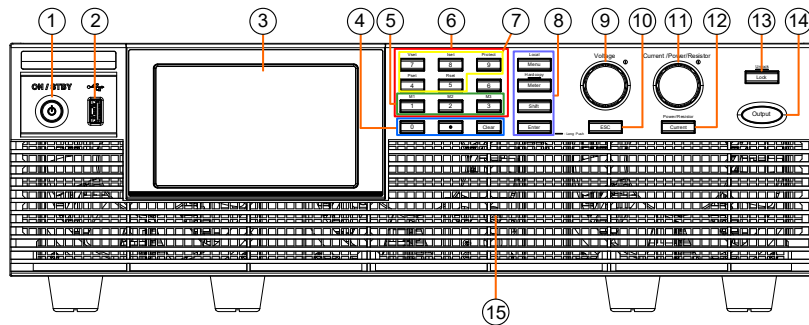

Option



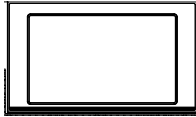

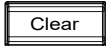

Part number	Description	
PHU-PC01	Parallel operation cable kit for 2 units	
PHU-PC02	Parallel operation cable kit for 3 units	
CW-0330M6-08	Input power cord 3m , PHU-C-5kW(3Phase AC200V)、 PHU-D-5kW、10kW、15kW(3Phase AC400V)	
CW-0330M6-14	Input power cord 3m , PHU-C10kW、15kW(3Phase AC200V)	
CW-0130M6-08	Input power cord 3m , PHU-B5kW(1Phase AC200V)	
CW-0130M6-14	Input power cord 3m , PHU-B10kW(1Phase AC200V)	
PHU-232	RS-232C CABLE & CONNECTOR KIT	
PHU-485	RS-485 CABLE & CONNECTOR KIT	

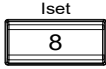
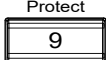
1-2. Appearance

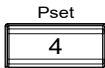
1-2-1. Front Panel

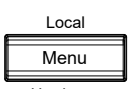
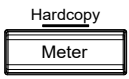
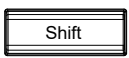

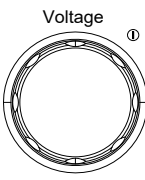
- | | | |
|----------------------------|---|--|
| 1. Power Switch | ON / STBY | Used to turn the power on/off. |
| |  | |
| 2. USB A Port |  | USB A port for data transfer. |
| |  | |
| 3. 5-inch TFTLCD Display |  | The display area. |
| 4. Button of Paid features |  | (+Shift) customized |
| Clear Button |  | Clear values |
| 5. M1/M2/M3 Button |  | (+Shift) Recall the M1/M2/M3 setup |
| 6. Numeric Keypad |  | Used to set various parameter values |
| 7. Vset Button |  | (+Shift) Set the output voltage value |
| Iset Button |  | (+Shift) Set the output current value |
| Protect Button |  | (+Shift) switch to the "Protect Status" page |

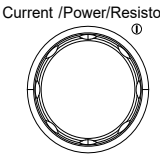
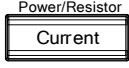
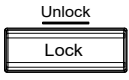
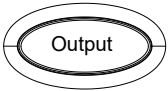
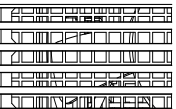
Pset Button		(+Shift) Set the output power value
Rset Button		(+Shift) Set the resistance value
8. Menu Button		PHU menu button
Local Button		Switch to "Local" page. (When remote controlling)
Meter Button		Switch the "Meter" page
Hardcopy Button		(Long push) Copy the screenshot to the USB Storage
Shift Button		Used to enable the functions that are written in blue characters above certain buttons.
Enter Button		Used to enter the value.
9. Voltage Knob		Used to set the voltage value or select a parameter number in the Menu.
10. Esc Button		Function "Esc" in Menu.
11. Current/ Power/Resist or Knob		Used to set the current value, power value or resistor value.
12. Current Button		Used to switch the page of Power / Resistor / Current settings.
13. Lock Button		Used to lock all front panel buttons other than the Output Button.
Unlock Button		(Long push) Used to unlock the front panel buttons.
14. Output Button		Used to turn the output on or off.
15. Air Inlet		Air inlet for cooling the inside of the PHU series.

1-2-2. PHU Series Display and Operation Panel

Normal type

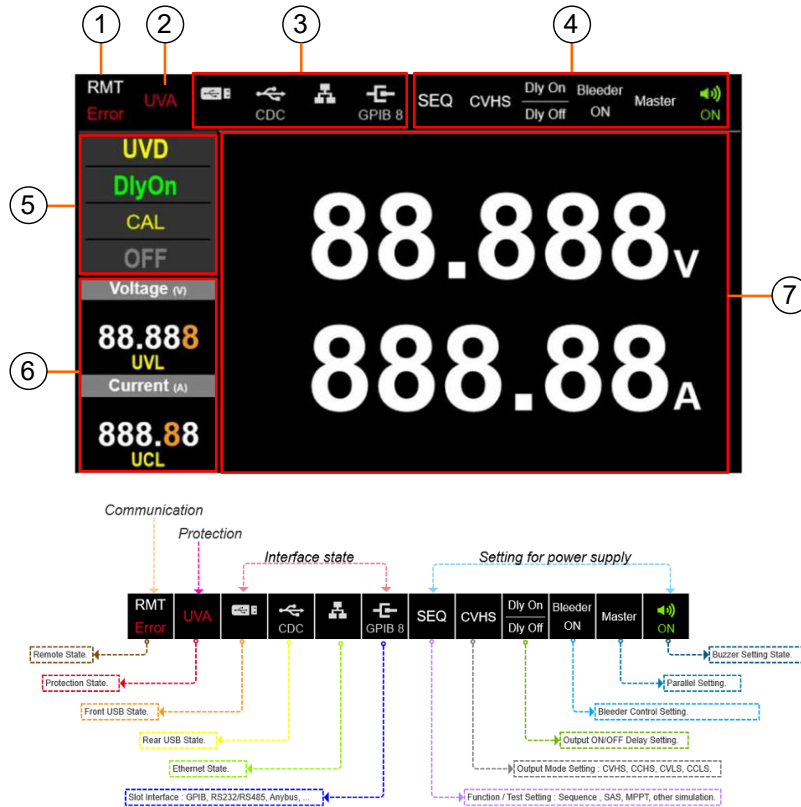

1. Block of Communication Displays the Remote state.
2. Block of Protection Displays the Protection state.
3. Block of interface state
 - a. Displays the Front USB state.
 - b. Displays the Rear USB state.
 - c. Displays the Ethernet state.
 - d. Displays the GPIB, RS232/RS485.
4. Block of setting
 - a. Displays the Function/Test Setting: Sequence, SAS and other simulation
 - b. Displays the Output Mode Setting: CVHS, CCHS, CVLS, CCLS
 - c. Displays the Output On/Off Delay Setting.
 - d. Displays the Bleeder Control Setting.
 - e. Displays the Parallel Setting.
 - f. Displays the Buzzer Setting.
5. Block of output State
 - a. Displays the Detect State.

- b. Displays the Delay Output State.
 - c. Displays the Fan State.
 - d. Displays the Output State.
6. Block of output Setting Displays the Setting of voltage, current, power, resistance
 7. Block of Meter Displays the voltage, current, power, and the ratio of the measured value to the maximum value.(bar)

For example

PHU-153M500

The bar below the voltage is the ratio of the 100 V to the maximum value.(500 V)





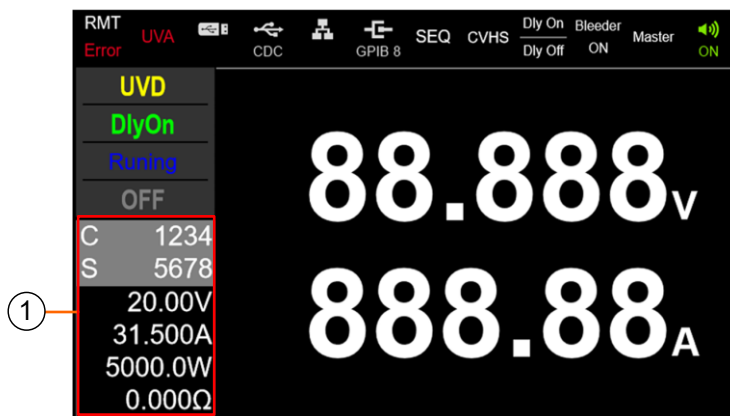



Sequence type

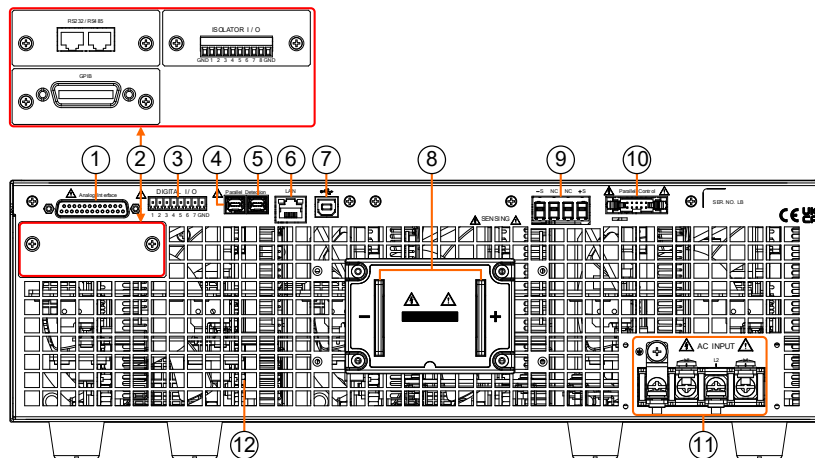

1. Block of Function Setting Displays the Setting of Function and status.
(Sequence, SAS and other simulation)

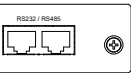
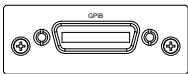
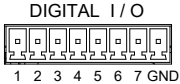
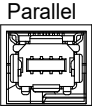
1-2-3. Rear Panel

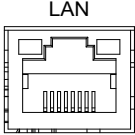

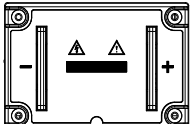
1. Analog Interface  External analog control connector.
2. Optional Interface  RS-232C / RS-485
 GP-IB
3. Digital Interface  Digital I/O is an interface that adds the ability to input and output digital signals.
4. Parallel Port  Parallel
Mini I/O: communication in parallel (Digital Output)
5. Detection Port  Detection
Mini I/O: communication in parallel (Digital Input)
6. LAN  LAN
Ethernet port for controlling the PHU remotely.
7. USB 
 USB port for controlling the PHU remotely.
8. DC Output  Output terminals

9. Sensing Terminals

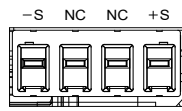

Compensation of load wire drop.

10. Parallel Connector

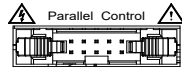

2X5 PIN Ejector header for communication in parallel (analogy)

11. AC Input

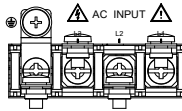

Input terminals

12. Air Outlet

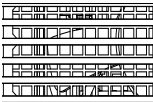

Air inlet for cooling the inside of the PHU series.

1-3. Theory of Operation

The theory of operation chapter describes the basic principles of operation, protection modes and important considerations that must be taken into account before use.

1-3-1. Operating Area Description

Background The PHU power supplies are regulated DC power supplies with a high voltage and current output.

These operate in CC or CV mode within a wide operating range limited only by the output power.

The operating area of each power supply is determined by the rated output power as well as the voltage and current rating.

Below is a comparison of the operating areas of each power supply.

PHU 80V Series Operating Area

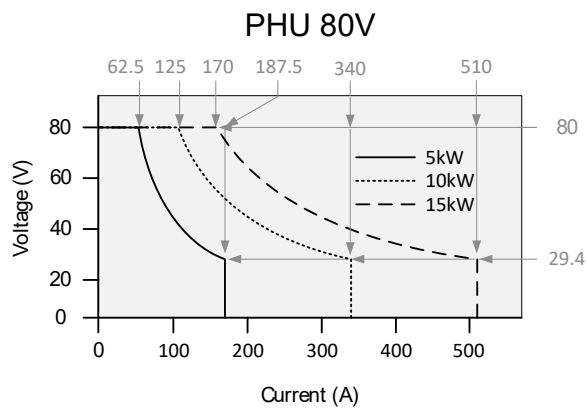

PHU 200V Series Operating Area

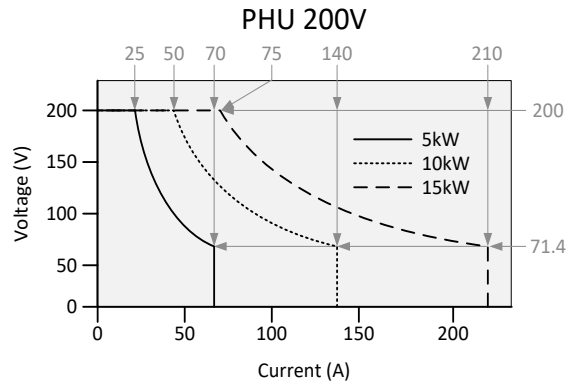

PHU 500V Series Operating Area

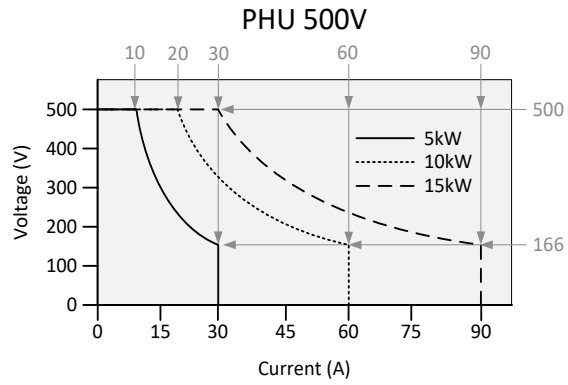

PHU 750V Series Operating Area

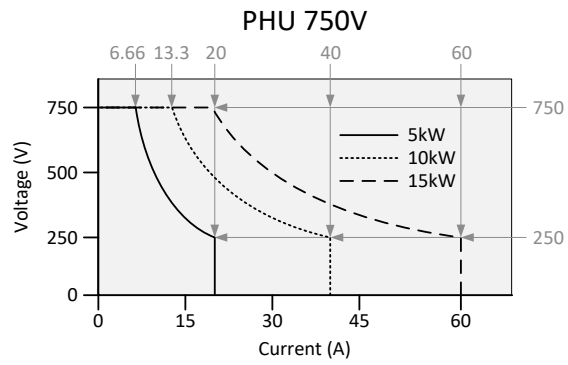

PHU 1000V Series Operating Area

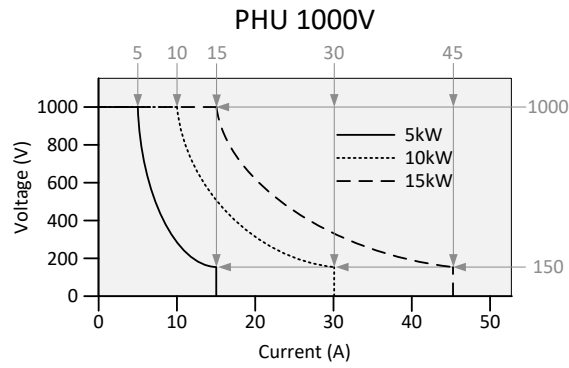

PHU 1500V Series Operating Area

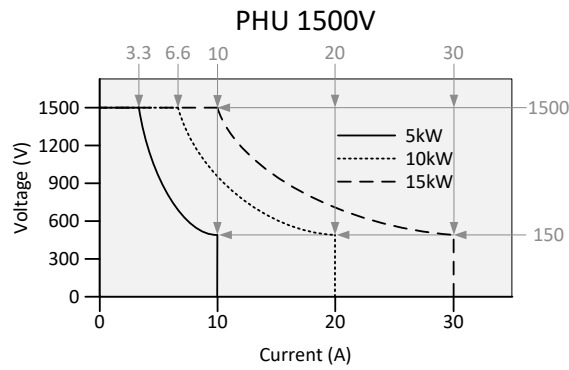

1-3-2. CC and CV Mode

CC and CV mode Description When the power supply is operating in constant current mode (CC) a constant current will be supplied to the load. When in constant current mode the voltage output can vary, whilst the current remains constant. When the load resistance increases to the point where the set current limit (ISET) can no longer be sustained the power supply switches to CV mode. The point where the power supply switches modes is the crossover point.

When the power supply is operating in CV mode, a constant voltage will be supplied to the load, whilst the current will vary as the load varies. At the point that the load resistance is too low to maintain a constant voltage, the power supply will switch to CC mode and maintain the set current limit.

The conditions that determine whether the power supply operates in CC or CV mode depends on the set current (ISET), the set voltage (VSET), the load resistance (R_L) and the critical resistance (R_C). The critical resistance is determined by $VSET/ISET$. The power supply will operate in CV mode when the load resistance is greater than the critical resistance. This means that the voltage output will be equal to the VSET voltage but the current will be less than ISET. If the load resistance is reduced to the point that the current output reaches the ISET level, the power supply switches to CC mode.

Conversely the power supply will operate in CC mode when the load resistance is less than the critical resistance. In CC mode the current output is equal to ISET and the voltage output is less than VSET.

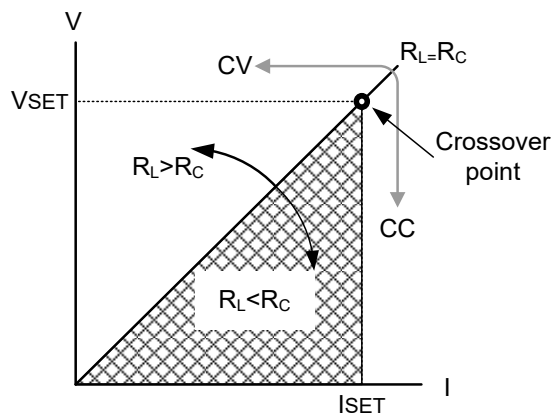

For loads that generate a transient surge voltage, VSET must be set so that the surge voltage does not reach the voltage limit.

For loads in which transient peak current flows, ISET must be set so that the peak value does not reach the current limit.

1-3-3. Slew Rate

Theory

The PHU has selectable slew rates for CC and CV mode. This gives the PHU power supply the ability to limit the current/voltage draw of the power supply. Slew rate settings are divided into High Speed Priority and Slew Rate Priority. High speed priority mode will use the fastest slew rate for the instrument. Slew Rate Priority mode allows for user adjustable slew rates for CC or CV mode. The rising and falling slew rate can be set independently.

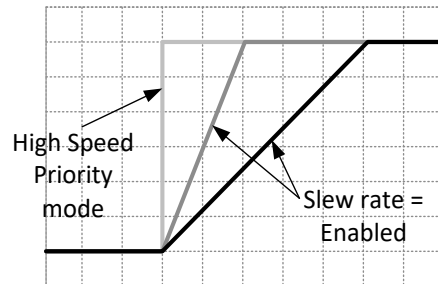

1-3-4. Bleeder Control

Background

The PHU DC power supplies employ a bleed resistor in parallel with the output terminals.

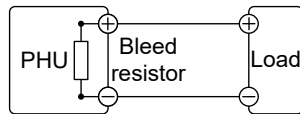

Bleed resistors are designed to dissipate the power from the power supply filter capacitors when power is turned off and the load is disconnected.

Without a bleed resistor, power may remain charged on the filter capacitors for some time and be potentially hazardous.

In addition, bleed resistors also allow for smoother voltage regulation of the power supply as the bleed resistor acts as a minimum voltage load.

The bleed resistance can be turned on or off using the configuration settings.



By default the bleed resistance is on. For battery charging applications, be sure to turn the bleed resistance off as the bleed resistor can discharge the connected battery when the unit is off.

1-3-5. Internal Resistance

Background On the PHU, the internal resistance of the power supply can be user-defined in software. (Internal Resistance Setting, see the Normal Settings on page 74.) When the internal resistance is set it can be seen as a resistance in series with the positive output terminal. This allows the power supply to simulate power sources that have internal resistances such as lead acid batteries. By default the internal resistance is 0 Ω .

Internal Resistance Range	Unit Model	Internal Resistance Range
	PHU-502L80	(0.0000 to 0.4706) Ω
PHU-103L80	(0.0000 to 0.2353) Ω	
PHU-153L80	(0.0000 to 0.1569) Ω	
PHU-502L200	(0.0000 to 2.8571) Ω	
PHU-103L200	(0.0000 to 1.4286) Ω	
PHU-153L200	(0.0000 to 0.9523) Ω	
PHU-502M500	(0.000 to 16.667) Ω	
PHU-103M500	(0.000 to 8.333) Ω	
PHU-153M500	(0.0000 to 5.5556) Ω	
PHU-502M750	(0.000 to 37.500) Ω	
PHU-103M750	(0.000 to 18.750) Ω	
PHU-153M750	(0.000 to 12.500) Ω	
PHU-502H1000	(0.00 to 66.67) Ω	
PHU-103H1000	(0.000 to 33.333) Ω	
PHU-153H1000	(0.000 to 22.222) Ω	
PHU-502H1500	(0.00 to 150.00) Ω	
PHU-103H1500	(0.00 to 75.00) Ω	
PHU-153H1500	(0.000 to 50.000) Ω	

1-3-6. Alarms

The PHU power supplies have a number of protection features. When one of the protection alarms is tripped, the ALM icon on the display will be lit and the type of alarm that has been tripped will be shown on the display. When an alarm has been tripped the output will be automatically turned off. For details on how to clear an alarm or to set the protection modes, please see page 39.

OVP	Over voltage protection (OVP) prevents a high voltage from damaging the load. This alarm can be set by the user.
OCP	Over current protection prevents high current from damaging the load. This alarm can be set by the user.
OPP	Over power protection prevents high power from damaging the load. This alarm can be set by the user.
PUF	Power Unit Fail. This alarm function is activated when a Power Unit is detected, including over temperature protection.
SENSE	Sense alarm. This alarm will detect if the sense wires have been connected to the wrong polarity.
AC FAIL	AC Fail. This alarm function is activated when a low AC input is detected.
Shutdown	Force Shutdown is not activated as a result of the PHU series detecting an error. It is a function that is used to turn the output off through the application of a signal from the rear panel analog control connector when an abnormal condition occurs.
Power limit	Power limit. This alarm function is activated when a power limit is detected.

1-3-7. Considerations

The following situations should be taken into consideration when using the power supply.

Inrush current When the power supply switch is first turned on, an inrush current is generated. Ensure there is enough power available for the power supply when first turned on, especially if a number of units are turned on at the same time.

Pulsed or Peaked loads When the load has current peaks or is pulsed, it is possible for the maximum current to exceed the mean current value. The PHU power supply ammeter only indicates mean current values, which means for pulsed current loads, the actual current can exceed the indicated value. For pulsed loads, the current limit must be increased, or a power supply with a greater capacity must be chosen. As shown below, a pulsed load may exceed the current limit and the indicated current on the power supply ammeter.

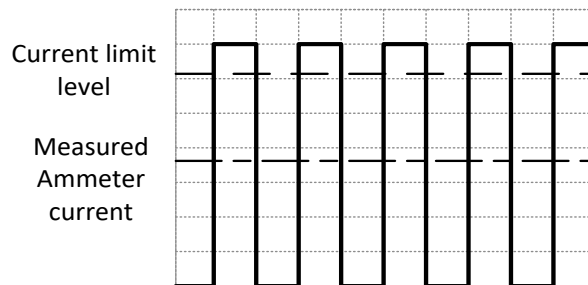

Reverse Current: When the power supply is connected to a regenerative load such as a transformer or inverter, reverse current will feed back to the power supply. The PHU power supply cannot absorb reverse current.

Regenerative load For loads that generate reverse current, connect an external resistor in parallel with the power supply to bypass the reverse current. This description only applies when the bleed resistance is off.

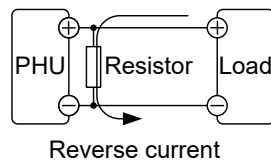

The current output will decrease by the amount of current absorbed by the resistor.

Ensure the resistor used can withstand the power capacity of the power supply/load.

Reverse Current: When the power supply is connected to a load such as a battery, reverse current may flow back to the power supply. To prevent damage to the power supply, use a reverse-current-protection diode in series between the power supply and load.

Accumulative energy.

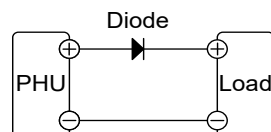



Ensure the reverse withstand voltage of the diode is able to withstand 2 times the rated output voltage of the power supply and the forward current capacity can withstand twice to 10 times the rated output current of the power supply.

Ensure the diode is able to withstand the heat generated in the following scenarios.

When the diode is used to limit reverse voltage, remote sensing cannot be used.

1-3-8. Grounding

The output terminals of the PHU power supplies are isolated with respect to the protective grounding terminal. The insulation capacity of the load, the load cables, and other connected devices must be taken into consideration when connected to the protective ground or when floating.

Floating

As the output terminals are floating, the load and all load cables must have an insulation capacity that is greater than the isolation voltage of the power supply.

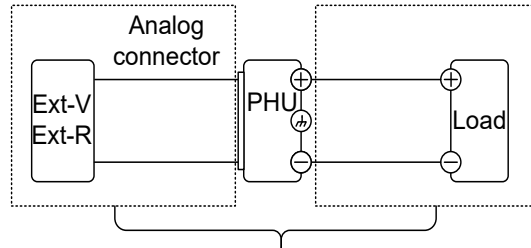

(-----) Insulation capacity \geq isolation voltage of power supply



If the insulation capacity of the load and load cables are not greater than the isolation voltage of the power supply, electric shock may occur.

Grounded output terminal

If the positive or negative terminal is connected to the protective ground terminal, the insulation capacity needed for the load and load cables is greatly reduced. The insulation capacity only needs to be greater than the maximum output voltage of the power supply with respect to ground.

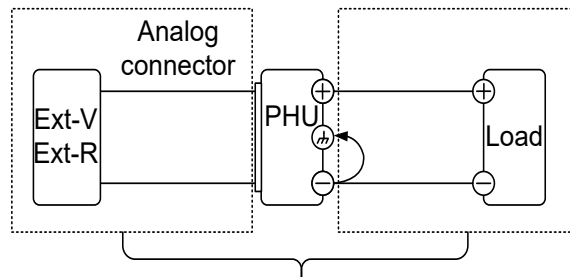

(-----) Insulation capacity \geq voltage of power supply with respect to ground



If using external voltage control, do not ground the external voltage terminal as this will create a short circuit.

2. OPERATION

2-1. Set Up

2-1-1. Line Voltage Connection

Background The PHU power supplies support universal power input, compatible with 3-Phase (180 to 265) Vac and 3-Phase (342 to 528) Vac systems. Follow the procedure below to connect or replace the power cord (user-supplied, specifications provided below):



- Ask for professional technician for installation.
 - The permanently connected power input is used as the disconnecting device and shall remain readily operable.
 - a. A switch or circuit-breaker must be included in the installation.
 - b. It must be suitably located and easily reached.
 - c. It must be marked as the disconnecting device for the equipment.
 - d. It shall be located near the equipment.
 - e. Do not position the equipment so that it is difficult to operate the disconnecting device.
 - f. It shall not interrupt the protective earth conductor.
 - g. It shall be complied with EN 60947 series, the rated voltage shall be at least equal to the rated input voltage of the equipment and the rated current shall be equal to the rated input current of the equipment.
-

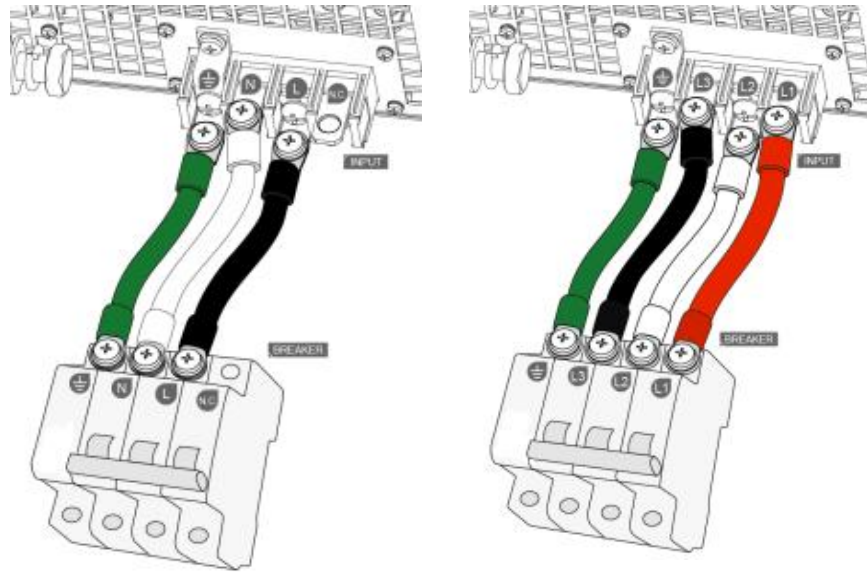

	Type B	Type C	
Recommended Power Cord Specifications	PHU-C type		
	5KW: 32A 200 V to 240 V, 8 AWG to 4 AWG, M6 screw type, screw torque value: 3.1 N.m	10KW: 56A 200 V to 240 V, 6 AWG to 4 AWG, M6 screw type, screw torque value: 3.1 N.m	15KW: 56A 200 V to 240 V, 6 AWG to 4 AWG, M6 screw type, screw torque value: 3.1 N.m
	PHU-D type		
	5KW: 16A 380 V to 480 V, 12 AWG to 4 AWG, M6 screw type, screw torque value: 3.1 N.m	10KW: 28A 380 V to 480 V, 10 AWG to 4 AWG, M6 screw type, screw torque value: 3.1 N.m	15KW: 28A 380 V to 480 V, 10 AWG to 4 AWG, M6 screw type, screw torque value: 3.1 N.m

Note There are two type power cord protective sheaths in the standard accessories. One is M32-size and it is used for PHU-C type. The other is M25-size and it is used for PHU-D type.

Installation 1. Connect the AC power cord wires to the AC input terminals.

Type B

- Red → Line (L1)
- White → Line (L2)
- Black → Line (L3)
- Green /Green & Yellow →Ground (⊕)

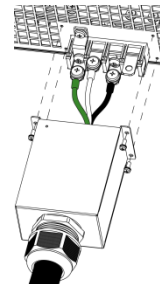

Type C or D

- Red → Line (L1)
- White → Line (L2)
- Black → Line (L3)
- Green /Green & Yellow →Ground (⊕)

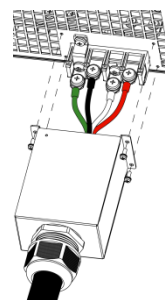

• Wire gauge: Please refer to the Recommended Power Cord Specifications.

• Wire diameter: Please refer to the Recommended Power Cord Specifications.

2. Make sure the sheath is tightened to the lock nut.

3. Re-install the power cord cover.

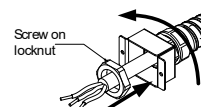

Removal

1. Turn off the power switch and circuit breaker.

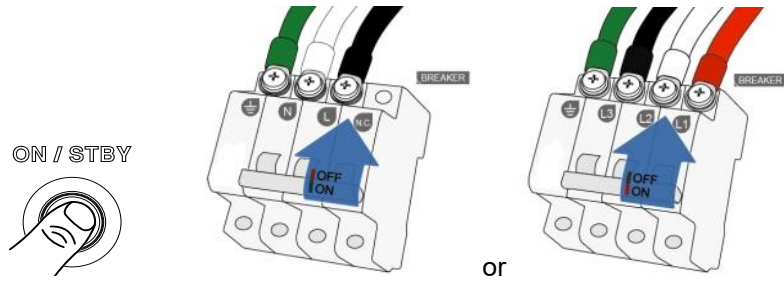

2. Unscrew the power cord protective sheath.
3. Remove the 4 screws holding the power cord cover and remove.
4. Remove the AC power cord wires with a Phillips screwdriver.

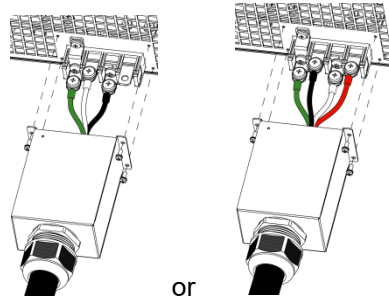

2-1-2. Power Up

Steps	1. Connect the power cord to the universal power input.	Page 21
	2. Press the ON/STBY button.	ON / STBY
	3. The button light will change from red to orange, and finally to green.	
	4. The power supply screen will display the TEXIO logo startup screen when it is powered on.	



Note	You may also configure how the PHU will behave on startup by altering the Power On Configuration settings, see page 79.
------	---

Power Down	To turn off the PHU power supply, press the ON/STBY button again. The button light will change from green to orange, and then to red. It may take a few seconds for the power supply to fully power down.
------------	---



The power supply takes around 8 seconds to fully turn on or shutdown.

Do not turn the power on and off quickly. Please wait for the display to fully turn off.

The power switch that is included in the instrument is not considered a disconnecting device.

The circuit breaker/switch on the fixed wiring is used as the disconnecting device.

2-1-3. Wire Gauge Considerations

Background Before connecting the output terminals to a load, the wire gauge of the cables should be considered.

It is essential that the current capacity of the load cables is adequate. The rating of the cables must equal or exceed the maximum current rated output of the instrument.

Recommended wire gauge	Wire Gauge (AWG)	Nominal Cross Section(sq)	Maximum Current(A)
	20	0.5	9
	18	0.75	11
	18	1	13
	16	1.5	18
	14	2.5	24
	12	4	34
	10	6	45
	8	10	64
	6	16	88
	4	25	120
	2	32	145
	1	50	190
	00	70	240
	000	95	290
	0000	120	340

Note The maximum operation current depends on the maximum allowable temperature of the insulation on the cable.

Under this condition, above table figures the maximum current that insulation's temperature rise should be under 60 degree and ambient temperature must be less than 30 degrees.

To minimize noise pickup or radiation, the load wires and remote sense wires should be twisted-pairs of the shortest possible length. Shielding of the sense leads may be necessary in high noise environments. Where shielding is used, connect the shield to the chassis via the rear panel ground screw. Even if noise is not a concern, the load and remote sense wires should be twisted-pairs to reduce coupling, which might impact the stability of the power supply. The sense leads should be separated from the power leads.

2-1-4. Output Terminals

Background Before connecting the output terminals to the load, first consider whether voltage sense will be used, the gauge of the cable wiring and the withstand voltage of the cables and load.

The output terminals are of two types:

- Two solid bars equipped with M10-size bolt and nuts for low-voltage output models. (PHU-80, PHU-200)
- Two solid bars equipped with M6-size bolt and nuts for high-voltage output models. (PHU-500, PHU-750, PHU-1000, PHU-1500)



Dangerous voltages. Ensure that the power to the instrument is disabled before handling the power supply output terminals. Failing to do so may lead to electric shock.

- Steps**
1. Turn the power off. ON / STBY

 2. Remove the output terminal cover. Page 28
 3. If necessary, connect the chassis ground terminal to either Page 20 the positive or negative terminal. See the grounding chapter for details.
 4. Choose a suitable wire gauge and crimping terminal for Page 26 the load cables.
 5. Connect the positive load cable to the positive output terminal and the negative cable to the negative output terminal.
 6. Reattach the output terminal cover. Page 28
-

Connection Example Use the included bolt set to connect the load cables to the output terminals.

(PHU-80, PHU-200 : M10-size bolt)

(PHU-500, PHU-750, PHU-1000, PHU-1500 : M6-size bolt)

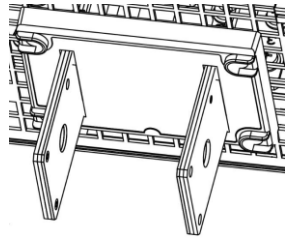
Make sure that the connections are tight and that washers and spring washers are used to ensure a good connection.



Low voltage output model

The user can use M10-sized screws and corresponding sized nuts to secure the lad cables

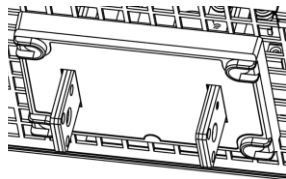

High voltage output model

The user can use M6-sized screws and corresponding sized nuts to secure the lad cables

2-1-5. Using the Output Terminal Cover

Steps

1. Unscrew the 4 screws beside the terminals.
2. Put the cover on the terminal.
3. Tighten the screws to secure the cover over the terminals.

(PHU-80V,
200V)

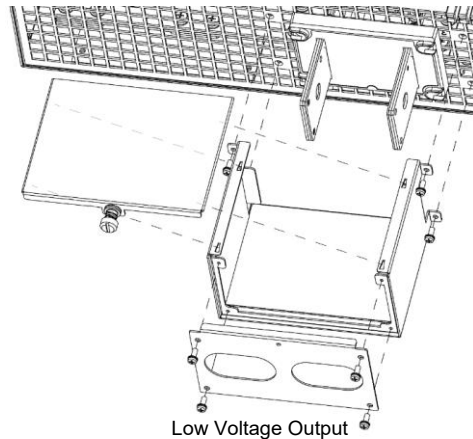

(PHU-500V,
750V, 1000V,
1500V)

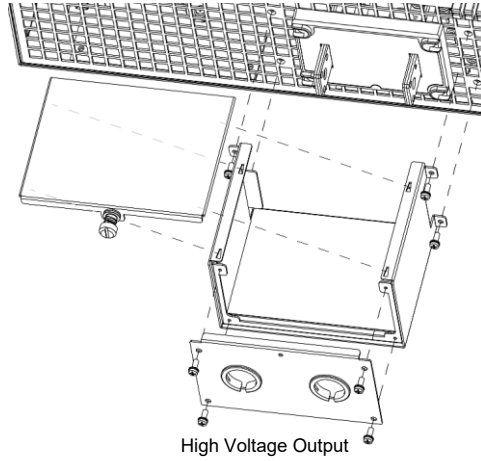

Removal Reverse the procedure to remove the terminal covers.

2-1-6. Using the Rack Mount Kit

Background The PHU series are designed to be directly mounted into 19 inch 3U rack mounts.

The PHU can be equipped with handles for easy installation in a rack.

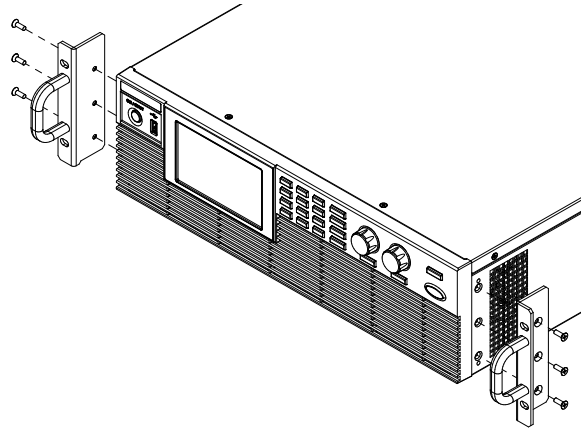

2-1-7. How to Use the Instrument

Background The PHU power supplies use the voltage, current knobs, number pad and some buttons to configure parameter values.

The voltage knobs are used to select the option in the main menu.

When the user manual says to set a value or parameter, use the steps below.

Example Set a voltage of 10.05 volts.

There are 3 methods to set the voltage value.

Method 1

1. Repeatedly press the Voltage knob until the target digit is highlighted. This will allow the voltage to be edited in 1 volt steps.

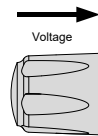

2. Turn the Voltage knob till 10 volts is shown on the voltage display.

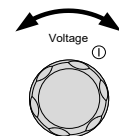

- Repeatedly press the Voltage knob until the target digit is highlighted. This will allow the voltage to be edited in 0.01 volt steps.

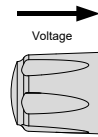

- Turn the Voltage knob till 10.05 volts is shown on the voltage display.

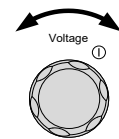

Method 2

- Press the Shift button and then press the 7 button in the number pad. It will be a place that can use the number pad to set the value directly.



- Press the Enter button after keying in the value.

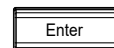

Method 3

1. Press the Menu button to enter the Menu page.

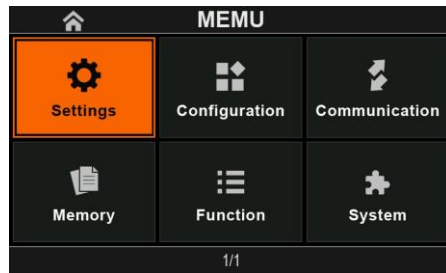
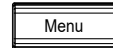

2. Press the Voltage knob to enter the Settings page.

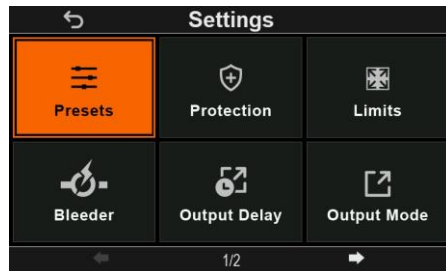
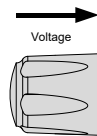

3. Press the Voltage knob to enter the Presets page.

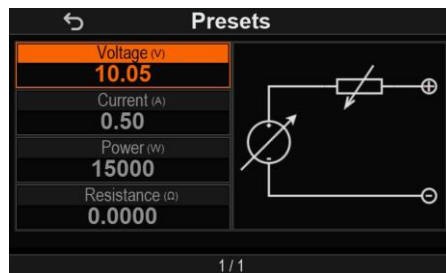
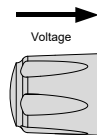

4. Press the Voltage knob, and it will be a place that can use the number pad to set the value directly.

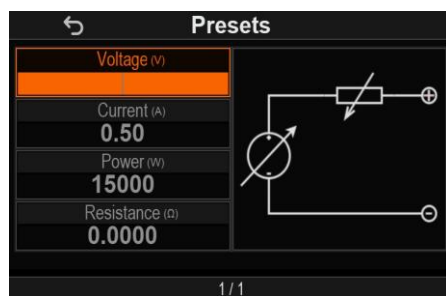

5. Press the Enter button after keying in the value.

Press the ESC button to return to the previous page.

Note

Press the Shift button and it will become illuminated to enable the functions that are written in blue characters above certain buttons.

2-1-8. Reset to Factory Default Settings

Background The setting allows the PHU to be reset back to the factory default settings. See page 145 for the default factory settings.

Steps 1. Press the Menu button.

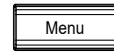

2. Rotate the Voltage knob to choose the "System" icon.

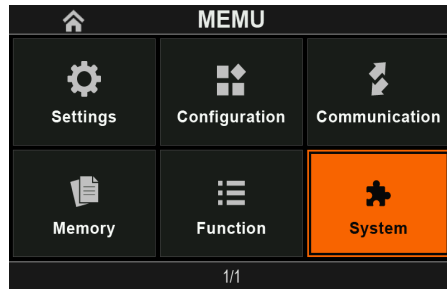
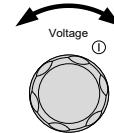

3. Press the Voltage knob to enter System Page.

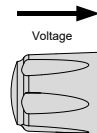

4. Rotate the Voltage knob to choose the "Factory default" icon.

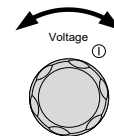

(There are two pages in the "System")

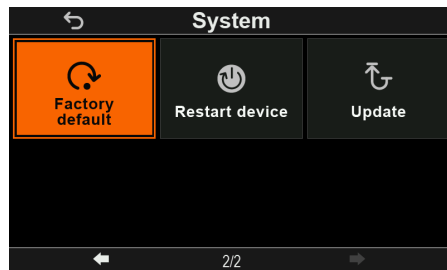

5. Press the Voltage knob.

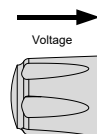

6. Rotate the Voltage knob to choose "Reset" in this window.

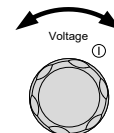

7. Press the Voltage knob to confirm Reset.

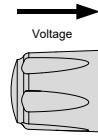

2-1-9. View System Version and Build Date

Background The setting allows you to view the PHU version number, build date, serial number and the module.

Steps 1. Press the Menu button.

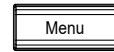

2. Rotate the Voltage knob to choose the "System" icon.

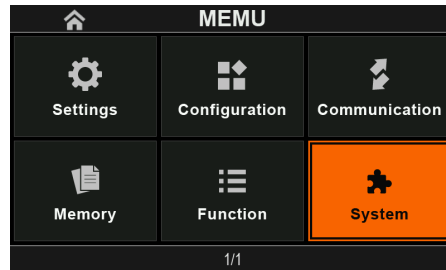
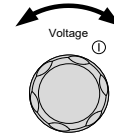

3. Press the Voltage knob to enter System Page.

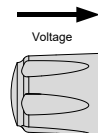

4. Rotate the Voltage knob to choose the "About" icon.

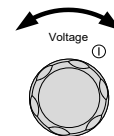

5. Press the Voltage knob.

The information of the version is in the window.

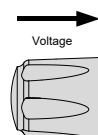

Example Operating System Version: 4.14.20241121



version Build Date: November 21, 2024

例

Software Version:01.34

SW version | 01.34

version

例

Firmware Version:065222A0

FW version | 065222A0

version

2-2. Basic Operation

Before operating the power supply, please see the Getting Started chapter, page 1.

2-2-1. Setting OVP/OCP/OPP

Background The OVP level, OCP level and OPP level have a selectable range that is based on the output voltage and output current, respectively. The OVP, OCP and OPP levels are set to the highest level by default. The actual selectable OVP, OCP and OPP range depends on the PHU model.

When one of the protection measures is on, the block of protection state is shown status on the screen. Pressing the enter button can resume. The “Shift”+”9” can be used to check protection that has been tripped, it can also clear any protection alarm. By default, the output will turn off when the protection levels are tripped.



Example

OVP alarm

Before setting the protection settings:

- Ensure the load is not connected.
- Ensure the output is turned off.

You can use the “Protection” settings to set up the values of OVP (over voltage protection), OCP (over current protection), OPP (over power protection) and each their Delay(s).

Steps

1. Press the Menu button to enter the main menu.

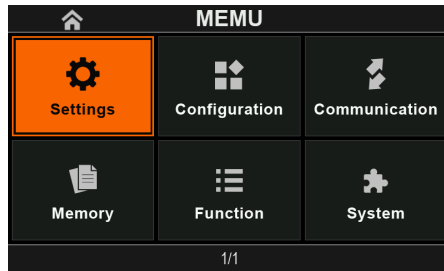
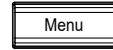

2. Press the Voltage knob to enter the Settings Page and rotate the Voltage knob to choose the “Protection” icon.

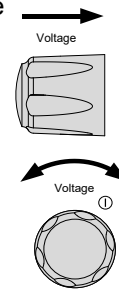
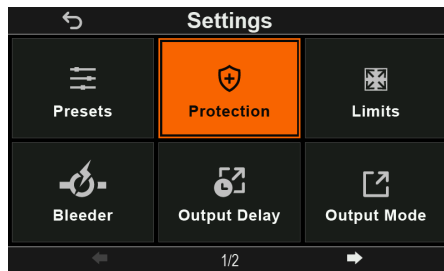

3. Press the Voltage knob to enter the Protection Page.

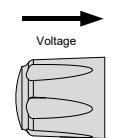
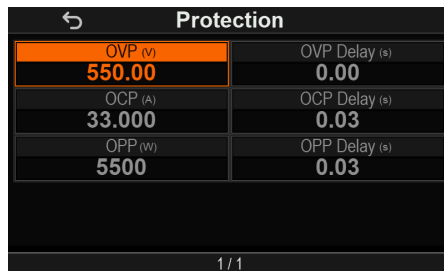

Choose a Protection Function

4. Then you can choose the OVP, OCP, and OPP settings by rotating the Voltage knob.

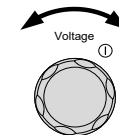

Setting the Protection Level

5. Press the Voltage knob and key in the value by number pad. Press the voltage knob again to enter the value.



6. If the setting is complete, press the ESC key to go back to the previous page.



2-2-2. OVP, OCP and OPP Setting Range

PHU Model	OVP	OCP	OPP
PHU-502L80	(5.00 to 88.00) V	(5.00 to 187.00) A	(100 to 5500) W
PHU-502L200	(5.00 to 220.00) V	(5.00 to 77.00) A	(100 to 5500) W
PHU-502M500	(5.00 to 550.00) V	(3.00 to 33.00) A	(100 to 5500) W
PHU-502M750	(5.0 to 825.0) V	(2.00 to 22.00) A	(100 to 5500) W
PHU-502H1000	(5.0 to 1100.0) V	(1.500 to 16.500) A	(100 to 5500) W
PHU-502H1500	(5.0 to 1650.0) V	(1.000 to 11.000) A	(100 to 5500) W
PHU-103L80	(5.00 to 88.00) V	(5.00 to 374.00) A	(200 to 11000) W
PHU-103L200	(5.00 to 220.00) V	(5.00 to 154.00) A	(200 to 11000) W
PHU-103M500	(5.00 to 550.00) V	(5.00 to 66.00) A	(200 to 11000) W
PHU-103M750	(5.0 to 825.0) V	(4.000 to 44.000) A	(200 to 11000) W
PHU-103H1000	(5.0 to 1100.0) V	(3.000 to 33.000) A	(200 to 11000) W
PHU-103H1500	(5.0 to 1650.0) V	(2.000 to 22.000) A	(200 to 11000) W
PHU-153L80	(5.00 to 88.00) V	(5.00 to 561.00) A	(300 to 16500) W
PHU-153L200	(5.00 to 220.00) V	(5.00 to 231.00) A	(300 to 16500) W
PHU-153M500	(5.00 to 550.00) V	(5.00 to 99.00) A	(300 to 16500) W
PHU-153M750	(5.0 to 825.0) V	(5.00 to 66.00) A	(300 to 16500) W
PHU-153H1000	(5.0 to 1100.0) V	(4.5 to 49.500) A	(300 to 16500) W
PHU-153H1500	(5.0 to 1650.0) V	(3 to 33.000) A	(300 to 16500) W

2-2-3. Delay Setting Range

PHU Model	OVP Delay	OCP Delay	OPP Delay
All series	(0.0 to 2.0) s	(0.1 to 2.0) s	(0.1 to 2.0) s

2-2-4. Setting UVL/OVL/UCL/OCL/OPL/ORL

Background You can use the “Limits” settings to apply limits to the voltage, current, power and Resistance settings respectively.

For example, if the Over Voltage limit is set to 88.888V, and the output voltage is adjusted beyond this value, the screen will display “OVL” and the value cannot exceed this limit.

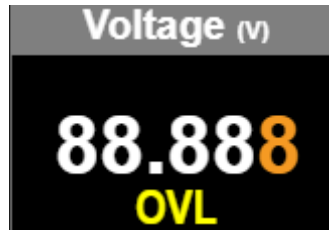

By using this feature, you can avoid turning the output off by mistakenly setting the voltage or current to a value that exceeds the set OVP or OCP level or to a value that is lower than the set UVL trip point.

You can use the “Limits” settings to set up the values of UVL (Under voltage Limit), OVL (Over Voltage Limit), UCL (Under Current Limit), OCL (Over Current Limit), OPL(Over power Limit) and ORL (Over Resistance Limit)

Steps

1. Press the Menu button to enter the main menu.

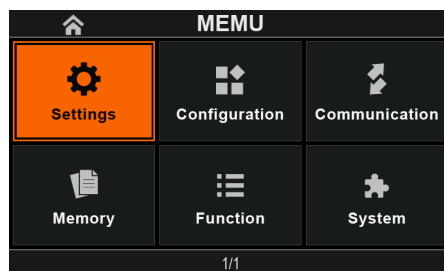
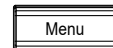

2. Press the Voltage knob to enter the Settings Page and rotate the Voltage knob to choose the “Limits” icon.

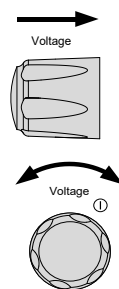
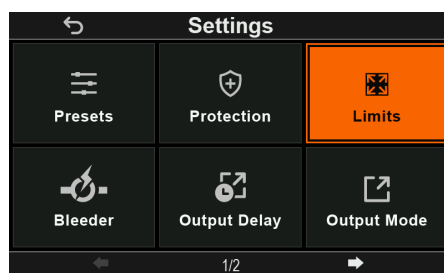

3. Press the Voltage knob to enter the Limits Page.

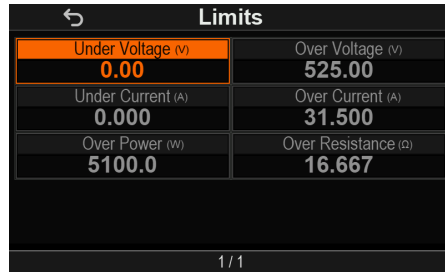

Limits	
Under Voltage (V) 0.00	Over Voltage (V) 525.00
Under Current (A) 0.000	Over Current (A) 31.500
Over Power (W) 5100.0	Over Resistance (Ω) 16.667

1 / 1

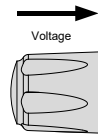

4. Then you can choose the UVL, OVL, UCL, OCL, OPL and ORL settings by rotating the Voltage knob.

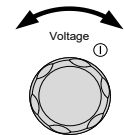

5. Press the Voltage knob and key in the value by number pad. Press the voltage knob again to enter the value.

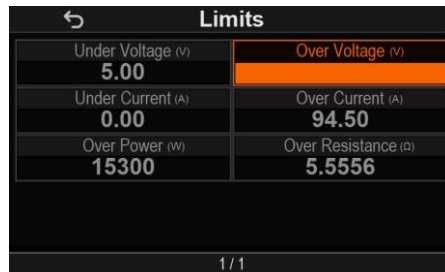

Limits	
Under Voltage (V) 5.00	Over Voltage (V) 94.50
Under Current (A) 0.00	Over Current (A) 15300
Over Power (W) 0.00	Over Resistance (Ω) 5.5556

1 / 1

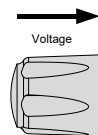

6. If the setting is complete, press the ESC key to go back to the previous page.



2-2-5. Setting Range

PHU Model	UVL & OVL	UCL & OCL	OPL	ORL
PHU-502L80	(0.00 to 84.00) V	(0.00 to 178.50) A	(0 to 5100) W	(0 to 0.4706) Ω
PHU-502L200	(0.00 to 210.00) V	(0.00 to 73.50) A	(0 to 5100) W	(0 to 2.8571) Ω
PHU-502M500	(0.00 to 525.00) V	(0.000 to 31.500) A	(0 to 5100) W	(0 to 16.667) Ω
PHU-502M750	(0.0 to 787.5) V	(0.000 to 21.000) A	(0 to 5100) W	(0 to 37.5) Ω
PHU-502H1000	(0.0 to 1050.0) V	(0.000 to 15.750) A	(0 to 5100) W	(0 to 66.6667) Ω
PHU-502H1500	(0.0 to 1575.0) V	(0.000 to 10.500) A	(0 to 5100) W	(0 to 150) Ω
PHU-103L80	(0.00 to 84.00) V	(0.00 to 357.00) A	(0 to 10200) W	(0 to 0.2352) Ω
PHU-103L200	(0.00 to 210.00) V	(0.00 to 147.00) A	(0 to 10200) W	(0 to 1.4286) Ω
PHU-103M500	(0.00 to 525.00) V	(0.00 to 63.30) A	(0 to 10200) W	(0 to 8.3333) Ω
PHU-103M750	(0.0 to 787.5) V	(0.000 to 42.000) A	(0 to 10200) W	(0 to 18.75) Ω
PHU-103H1000	(0.0 to 1050.0) V	(0.000 to 31.500) A	(0 to 10200) W	(0 to 33.3333) Ω
PHU-103H1500	(0.0 to 1575.0) V	(0.000 to 21.000) A	(0 to 10200) W	(0 to 75) Ω
PHU-153L80	(0.00 to 84.00) V	(0.00 to 535.50) A	(0 to 15300) W	(0 to 0.1569) Ω
PHU-153L200	(0.00 to 210.00) V	(0.00 to 220.50) A	(0 to 15300) W	(0 to 0.9524) Ω
PHU-153M500	(0.00 to 525.00) V	(0.00 to 94.50) A	(0 to 15300) W	(0 to 5.5556) Ω
PHU-153M750	(0.0 to 787.5) V	(0.00 to 63.00) A	(0 to 15300) W	(0 to 12.5) Ω
PHU-153H1000	(0.0 to 1050.0) V	(0.000 to 47.250) A	(0 to 15300) W	(0 to 22.2222) Ω
PHU-153H1500	(0.0 to 1575.0) V	(0.000 to 31.500) A	(0 to 15300) W	(0 to 50) Ω

2-2-6. Setting Bleeder Control

Background The Bleeder function helps to quickly discharge the internal capacitor, eliminating the potential danger of discharge. For battery charging applications, the Bleeder can be set to OFF to prevent any impact on the charging process.

Bleeder control turns ON/OFF the bleeder resistor. When set to AUTO the bleeder resistor is automatically turned on when the output is turned on and turned off when the output or power is turned off.

Steps

1. Press the Menu button to enter the main menu.

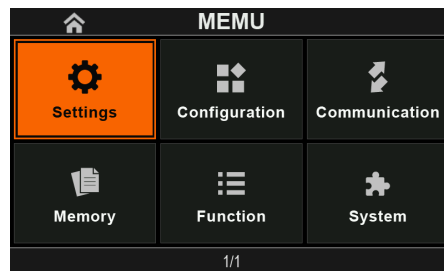
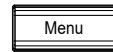

2. Press the Voltage knob to enter the Settings Page and rotate the Voltage knob to choose the "Bleeder" icon.

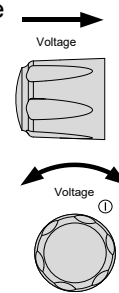
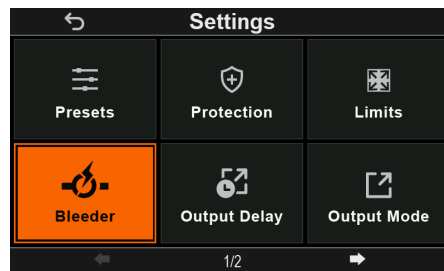

3. Press the Voltage knob to enter the Bleeder Page.

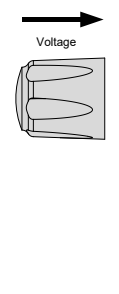
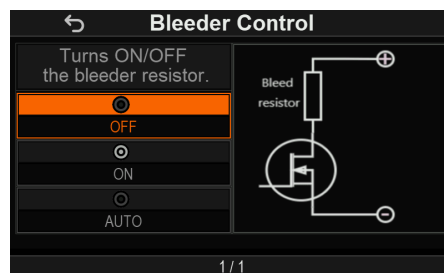

4. Users can choose the OFF, ON, and AUTO by rotating the Voltage knob.

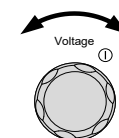

5. Press the Voltage knob to complete selection.

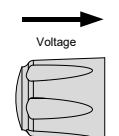

- If the setting is complete, press the ESC key to go back to the previous page.



2-2-7. Setting Output Mode

Constant Voltage (C.V.) Mode:

When the power supply is set to Constant Voltage (C.V.) mode, a current limit must also be set to determine the crossover point. Once the current exceeds this limit, the mode switches to Constant Current (C.C.) mode.

- | | |
|-----------|--|
| C.V. Mode | <ol style="list-style-type: none"> CVHS Mode (CV High Speed Priority) |
| Types | <ul style="list-style-type: none"> • Uses the fastest slew rate for the instrument. <ol style="list-style-type: none"> CCVLS Mode (CV Slew Rate Priority) <ul style="list-style-type: none"> • Uses a user-configured slew rate. (Users can set the rising voltage and falling voltage) |

Constant Current (C.C.) Mode:

When the power supply is set to Constant Current (C.C.) mode, a voltage limit must be set to determine the crossover point. Once the voltage exceeds this limit, the mode switches to Constant Voltage (C.V.) mode.

- | | |
|-----------|--|
| C.C. Mode | <ol style="list-style-type: none"> CCHS Mode (CC High Speed Priority) |
| Types | <ul style="list-style-type: none"> • Uses the fastest slew rate for the instrument. <ol style="list-style-type: none"> CCLS Mode (CC Slew Rate Priority) <ul style="list-style-type: none"> • Uses a user-configured slew rate. (Users can set the rising current, and falling current) |

For details about C.C. operation, see page 14. C.C. and C.V.

There are a total of four modes, and the user can choose which mode to use based on their needs.

Background Before setting the Output mode, ensure that:

- The output is off.
- The load is connected.

Steps 1. Press the Menu button to enter the main menu.

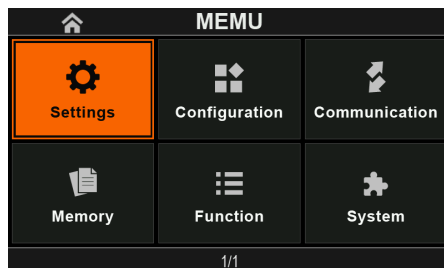
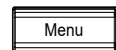

2. Press the Voltage knob to enter the Settings Page and rotate the Voltage knob to choose the "Output Mode" icon.

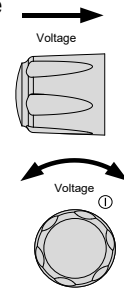
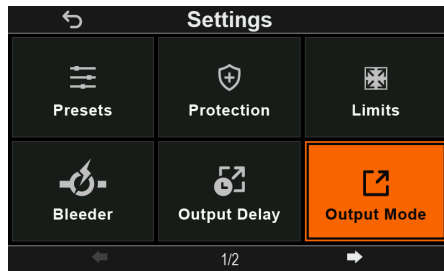

3. Press the Voltage knob to enter the Output Mode Page.

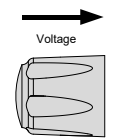
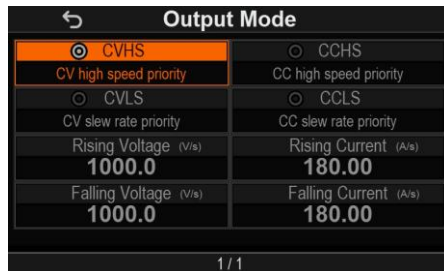

4. Users can choose the Output Mode by rotating the Voltage knob. Press the Voltage knob to complete selection.

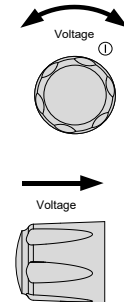

5. If the user selects the CVLS mode or CCLS mode, they can use the number pad to adjust the rising voltage, falling voltage, rising current, and falling current.

(Rotate the voltage knob to select the parameter to be set. Press the voltage knob, then use the number pad to enter the value. Press the voltage knob again to enter the value.)

6. If the setting is complete, press the ESC key to go back to the previous page.

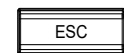

2-2-8. Setting Slew Rate Range

PHU Model	Voltage-Slew rate	Current-Slew rate
PHU-502L80	(0.01 to 160.00) V/S	(0.01 to 340.00) A/S
PHU-502L200	(0.01 to 400.00) V/S	(0.01 to 140.00) A/S
PHU-502M500	(0.1 to 1000.0) V/S	(0.001 to 60.000) A/S
PHU-502M750	(0.1 to 1500.0) V/S	(0.001 to 40.000) A/S
PHU-502H1000	(0.1 to 2000.0) V/S	(0.001 to 30.000) A/S
PHU-502H1500	(0.1 to 3000.0) V/S	(0.001 to 20.000) A/S
PHU-103L80	(0.01 to 160.00) V/S	(0.1 to 680.0) A/S
PHU-103L200	(0.01 to 400.00) V/S	(0.01 to 280.00) A/S
PHU-103M500	(0.1 to 1000.0) V/S	(0.01 to 120.0) A/S
PHU-103M750	(0.1 to 1500.0) V/S	(0.01 to 80.00) A/S
PHU-103H1000	(0.1 to 2000.0) V/S	(0.001 to 60.000) A/S
PHU-103H1500	(0.1 to 3000.0) V/S	(0.001 to 40.000) A/S
PHU-153L80	(0.01 to 160.00) V/S	(0.1 to 1020.0) A/S
PHU-153L200	(0.01 to 400.00) V/S	(0.01 to 420.00) A/S
PHU-153M500	(0.1 to 1000.0) V/S	(0.01 to 180.00) A/S
PHU-153M750	(0.1 to 1500.0) V/S	(0.01 to 120.00) A/S
PHU-153H1000	(0.1 to 2000.0) V/S	(0.01 to 90.00) A/S
PHU-153H1500	(0.1 to 3000.0) V/S	(0.001 to 60.000) A/S

2-2-9. Panel Lock

The panel lock feature prevents settings from being changed accidentally. When activated, the Lock key will become illuminated and all keys and knobs except the Lock key and Output key (if active) will be disabled.

If the instrument is remotely controlled via the USB/LAN interface, the panel lock is automatically enabled.

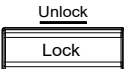
Activate the panel lock	Press the Lock key to activate the panel lock. The key will become illuminated.	
Disable the panel lock	Hold the Lock key for 3 seconds to disable the panel lock. The key's light will turn off.	

2-2-10. Save (memory) Setup

The PHU has 3 memory slots (M1, M2, M3) to save the various settings. Including Voltage, Current, Power, Resistance, OVP, OVP Delay, OCP, OCP Delay, OPP, OPP Delay, UVL, OVL, UCL, OCL, OPL, ORL, Bleeder Control and so on.

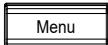
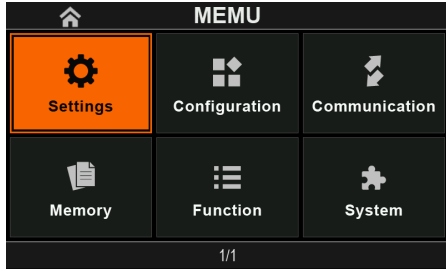
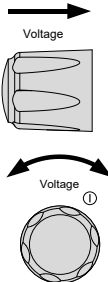
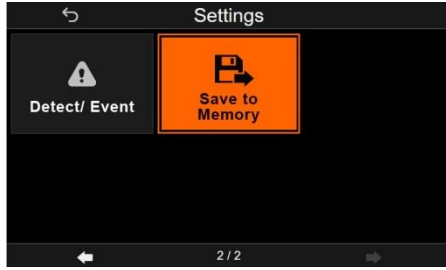
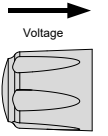
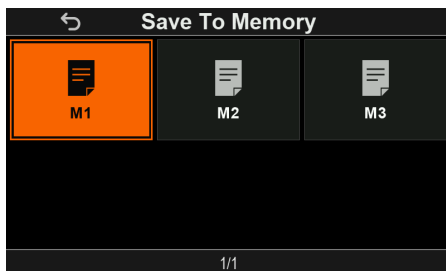
Steps	1. Press the Menu button to enter the main menu.	
		
	2. Press the Voltage knob to enter the Settings Page and rotate the Voltage knob to choose the "Save to Memory" icon. (On second page)	
		
	3. Press the Voltage knob to enter the Save to Memory Page.	
		

4. Users can choose the memory slot (M1, M2, M3) using the voltage knob, then press the voltage knob again to complete setting.
5. If the setting is complete, press the ESC key to go back to the previous page. 

2-2-11. Load (memory) Setup

Steps

1. Press the Menu button to enter the main menu. 

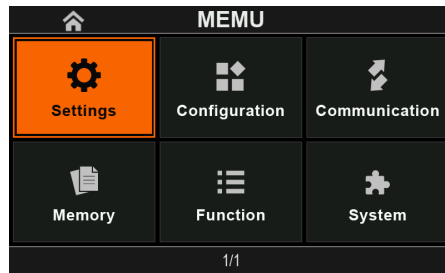

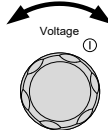
2. Rotate the Voltage knob to choose the "Memory" icon. 

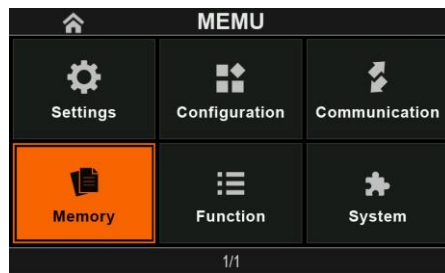

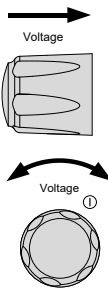
3. Press the Voltage knob to enter the Memory Page and rotate the Voltage knob to choose the memory slots.(M1, M2, M3) 

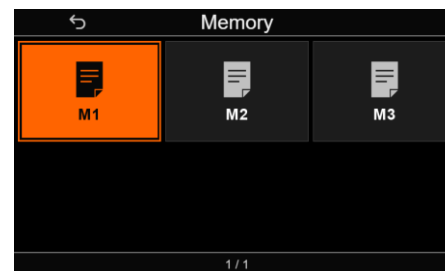

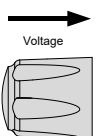
4. (For example, M1) Press the Voltage knob to enter the M1 Page. 

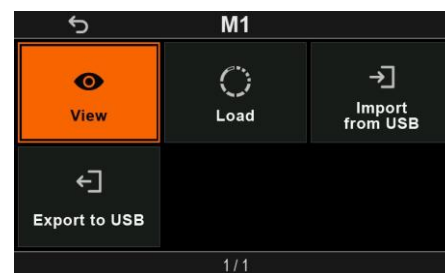

5. Rotate the Voltage knob to choose the “Load” icon. And Press the Voltage knob to complete loading memory.

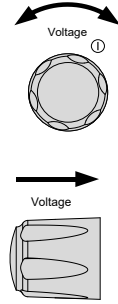
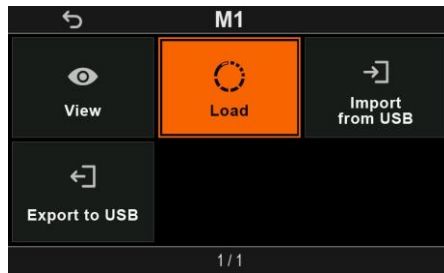

6. If the setting is complete, press the ESC key to go back to the previous page.



2-2-12. Voltage Sense

The PHU power supplies can be operated using remote voltage sense. By default the PHU ships configured for local sense.

Remote Sense Connector

The Remote Sense connector includes a detachable plug to facilitate making the sense connections.



Ensure the output is off before handling the remote sense connector.

Use sense cables with a voltage rating exceeding the isolation voltage of the power supply.

Never connect sensing cables when the output is on. Electric shock or damage to the power supply could result.

Remote Sense Connector Overview When using the remote sense connector make sure the wires that are used follow the following guidelines:

- Wire gauge: AWG 30 to AWG 8
- Wire diameter: 0.2 mm² to 6 mm²
- Strip length: 10 mm to 11 mm

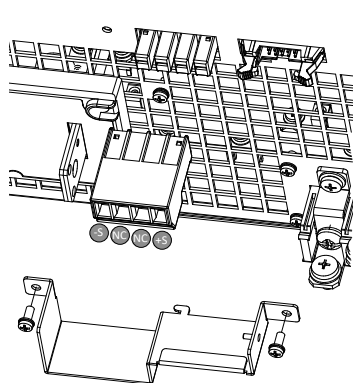

+S: Remote(+) sense

NC: Not connected

NC: Not connected

-S: Remote (-) sense

Remote Sense Cover

Local sense is only recommended when the voltage drop is of no consequence or for load-current applications. By default, the sense plug is already configured to local sensing.



Ensure that the output is off before handling the remote sense connector.

Use sense cables with a voltage rating exceeding the isolation voltage of the power supply.

Never connect sensing cables when the output is on. Electric shock or damage to the power supply could result.

Always operate the PHU with the remote sense cover.

Connector

1. Place the cover over the remote sense connector.
2. Secure the cover with the provided screw.

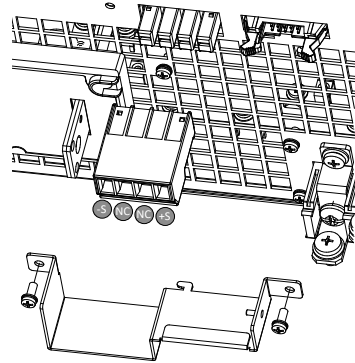

Local Sense

Local sense is only recommended when the voltage drop is of no consequence or for load-current applications. By default, the sense plug is already configured to local sensing.

Local Sense Connection

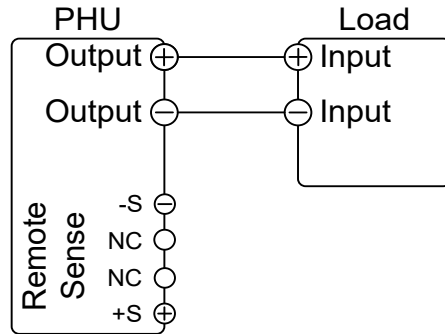

Remote Sense

Remote sense is used to compensate for the voltage drop seen across load cables due to the resistance inherent in the load cables. The remote sense terminals are connected to the load terminals of the DUT to determine the voltage drop across the load cables.

Model	Maximum Compensation Voltage (V)
PHU 80V Model	4 V
PHU 200V Model	10 V
PHU 500V Model	25 V
PHU 750V Model	37.5 V
PHU 1000V Model	50 V
PHU 1500V Model	75 V



Load cables should be chosen with a voltage drop less than the compensation voltage.

Do NOT bundle the sense wire-pair together with the load wires; keep the load wires and sense wires separate. Keep the sense wirepair as short as possible and twist or bundle it to reduce lead inductance and noise pickup.



Ensure the output is off before connecting any sense cables.

Use sense cables with a voltage rating exceeding the isolation voltage of the power supply.

Never connect sensing cables when the output is on. Electric shock or damage to the power supply could result.

Always connect the + sense lead to the + terminal of the load and the - sense lead to the - terminal of the load. If a sense lead opens during operation the output may momentarily overshoot. The two center sense terminals are not used.

Single Load

1. Connect the +S terminal to the positive potential of the load. Connect the -S terminal to the negative potential of the load.

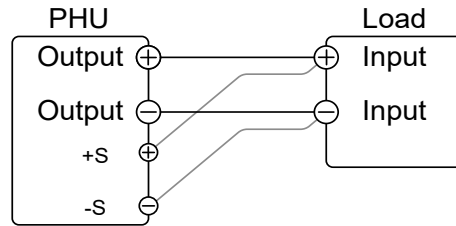

2. Operate the instrument as normal. See the Basic Operation chapter for details.
-

Parallel PHU Units

1. Connect the +S terminals to the positive potential of the load. Connect the -S terminals to the negative potential of the load.

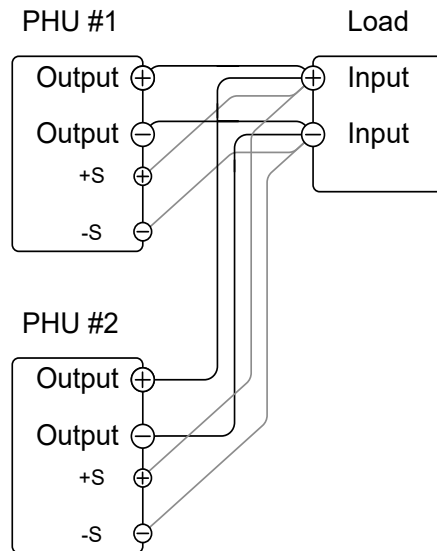

2. Operate the instrument as normal. See the Parallel Operation chapter for details.
-

Wire Shielding and Load line impedance

To help to minimize the oscillation due to the inductance and capacitance of the load cables, use an electrolytic capacitor in parallel with the load terminals.

To minimize the effect of load line impedance use twisted wire pairing.

Shield the sense wires and connect the shield to the chassis ground.

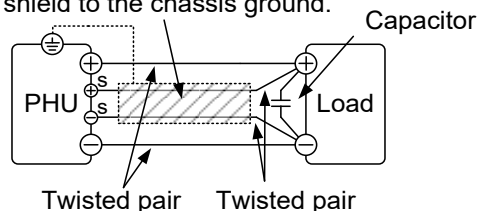

2-3. Parallel Operation

This section describes the basic operations required to operate the power supply in parallel. Operating the PHU series in parallel increases the total current output of the power supply units.

When the units are used in parallel, a number of precautions and limitations apply. Please read the following sections before operating the power supplies in parallel.

2-3-1. Master-Slave Parallel Overview

Background When connecting the PHU power supplies in parallel, up to 3 units can be used, and all units must have the same output voltage for parallel operation.

To use the power supplies in parallel, units must be used in a “master-slave” configuration. In the master-slave configuration a “master” power supply controls any other connected “slave” power supplies. In order for the master unit to control the slave units, the master unit must use the parallel control connector and parallel/detecting port to control the slave units.

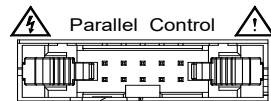
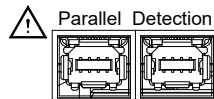

When using the parallel Control Connector, the connector must be wired correctly between the master and each of the slave units. (The following image is for reference.)

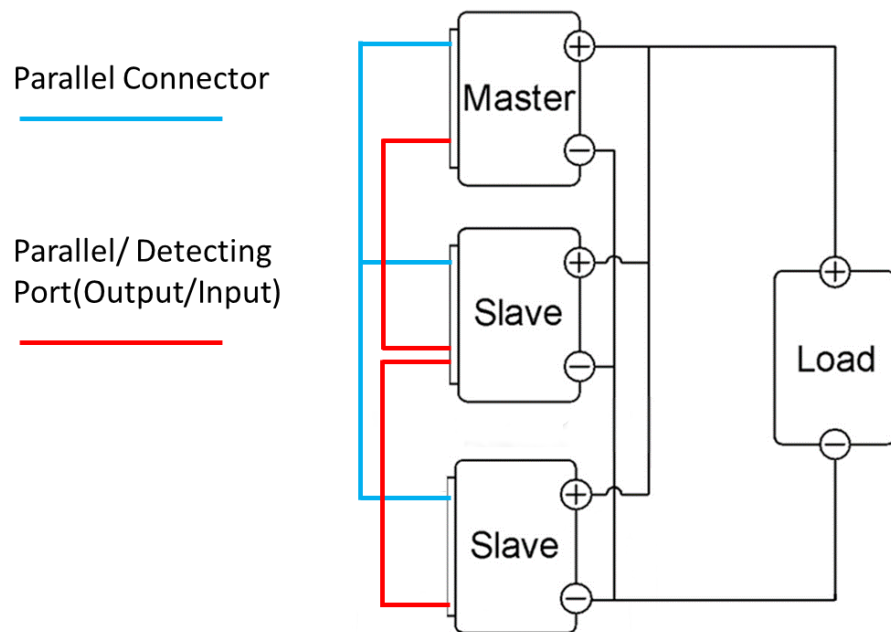

Limitations

Display

- Only the master unit will display the voltage and current.

OVP/OCP/OPP/UVL/OVL/UCL/OCL/OPL/ ORL

- Slave units follow the settings of the master when OVP/OCP/OPP/UVL/OVL/UCL/OCL/OPL/ORL is tripped on the master unit.

Remote monitoring

- Voltage monitoring and current monitoring are only supported on the master unit.
- The IMON current represents the total current of the all the parallelized units.

Remote Sense

- Please see the remote sense chapter for details, page 51.

Parallel Calibration

- The parallel calibration function can be used to offset cables losses.

External Voltage and Resistance Control

- Voltage/Resistance controlled remote control can only be used with the master unit.
- The full scale current (in parallel) is equivalent to the maximum external voltage or resistance.

Internal Resistance

For 2 units in parallel, the internal resistance is actually half of the setting value.

For 3 units in parallel, the internal resistance is actually a third of the setting value.

For 4 units in parallel, the internal resistance is actually a fourth of the setting value, and so on.

Bleeder Control

- The Master unit is used to control the bleeder setting. The bleeder setting of slave unit is the same as standalone. Be careful of bleeder setting before setting in parallel.

Output Current (For example, with three in parallel.)	PHU Model	1 unit	2 units	3 units
	PHU-502L80	170 A	340 A	510 A
	PHU-502L200	70 A	140 A	210 A
	PHU-502M500	30 A	60 A	90 A
	PHU-502M750	20 A	40 A	60 A
	PHU-502H1000	15 A	30 A	45 A
	PHU-502H1500	10 A	20 A	30 A
	PHU-103L80	340 A	680 A	1020 A
	PHU-103L200	140 A	280 A	420 A
	PHU-103M500	60 A	60 A	60 A
	PHU-103M750	40 A	80 A	120 A
	PHU-103H1000	30 A	60 A	90 A
	PHU-103H1500	20 A	40 A	60 A
	PHU-153L80	510 A	1020 A	1530 A
	PHU-153L200	210 A	420 A	630 A
	PHU-153M500	90 A	180 A	270 A
	PHU-153M750	60 A	120A	180 A
	PHU-153H1000	45 A	90 A	135 A
	PHU-153H1500	30 A	60 A	90 A

2-3-2. Parallel Connection

Parallel Connection To operate the power supplies in parallel with the parallel connectors, connect the Parallel connectors on the master and slave units as shown in the diagrams below.

Parallel/
Detecting port

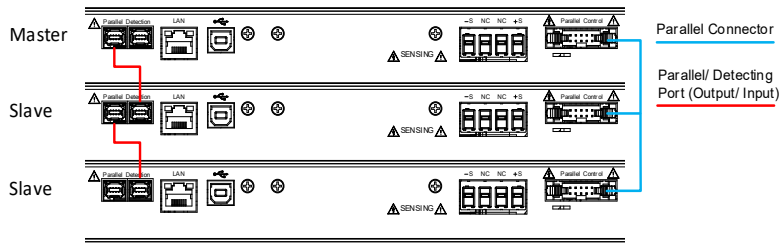

2-3-3. Parallel Operation

Master-Slave Configuration Before using the power supplies in parallel, the master and slave units need to be configured.

- Steps**
1. Configure the OVP, OCP, OPP, OVL, UCL, OCL, OPL, ORL and ULV settings for the master unit.
 2. For each unit, enter the menu, and choose the Configuration icon.

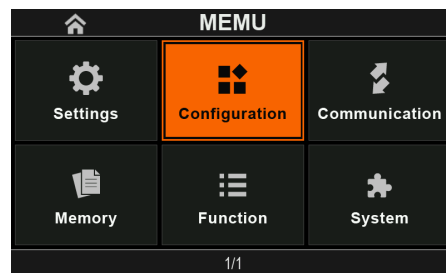

3. Choose the "Master-slave" icon in the Configuration page.

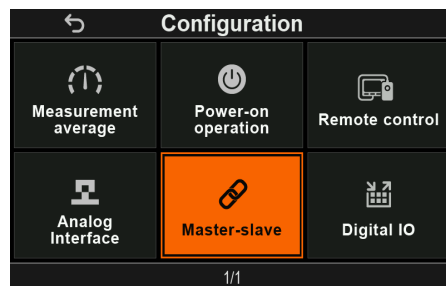

4. Users can set for each master/slave unit.



Single: The unit does not use parallel connection. (Default).



Master: The user can set Master unit.



Slave: The user can set Slave units numbered.

Note Configuration settings can be checked on both the master and slave units.
Only the Master OVP, OCP, OPP, OVL, UCL, OCL, OPL, ORL, ULV settings are used for protection. Slave protection levels are disregarded.

Master-Slave Operation Only operate the power supplies in parallel if the units are configured correctly.

Steps 1. Turn on the master and slave units. The slave unit(s) will show a "Slave" display.

Master unit



Slave units



2. Operation of all units is controlled via the master unit. Operation of the master unit is the same as for a single unit. See the Configuration chapter.

3. Press the Output key to begin. The output LED will become lit.

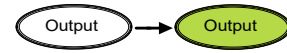

Only operate the power supplies in parallel if using units of the same model number.

Note

The panel controls are disabled on slave units, including the output key. On slave units, only the menu key can be used to view the current settings.

2-4. Sequence(Test Scripts)

This section describes how to use the Sequence function to run, load and save test scripts for automated testing. The Sequence function is useful if you want to perform a number of tests automatically. The PHU sequence function can store ten Sequence in memory.

To create each test script, refer to "Edit Sequence" on page 66, or create it based on the sample CSV file posted on our website.

<https://www.texio.co.jp>

2-4-1. Sequence File Format

Background The test files are saved in *.csv file format.
Each file is saved as tXXX.csv, where XXX is the save file number 001~010.

2-4-2. Sequence Settings

Sequence Run A script must first be imported from the USB before it can be run. Refer to the function 'Sequence Import' below. After importing the test scripts, load the chosen script. The PHU display will switch to the Sequence type. Press the Output button on the front panel, and the script will run as soon as the Sequence function is started.

Sequence Import Copies a sequence from the USB drive to the designated save slot in memory. A script must first be copied into internal memory before it can be run.

(USB→PHU)

Sequence Export Exports a script from the designated memory save slot to the USB drive.

(PHU→USB)

Sequence Delete Deletes the chosen test file from the PHU internal memory.

Sequence Edit Edit the testing steps in sequence.

2-4-3. Import Sequence from USB

Overview Before a Sequence can be run, it must first be loaded into one of the 10 memory save slots.

Before loading a Sequence into memory:

- Ensure the script file is placed in the root directory.
- Ensure the file name number corresponds to the memory number that you wish to save to. For example t001.csv can only be loaded into memory number #01, t002.csv into memory number #02, and so on.

Steps

1. Insert a USB flash drive into the front panel USB-A slot. Ensure the flash drive contains a Sequence in the root directory.



2. Press the Menu button and choose the “Function” icon.

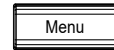

3. Choose the “Sequence” icon in the Function page.

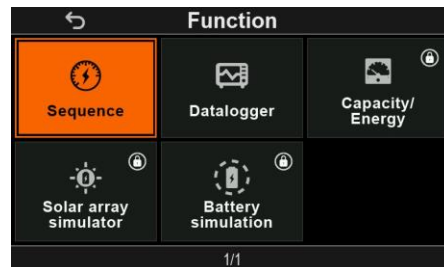

4. Choose the “Import from USB” icon in the Sequence page.

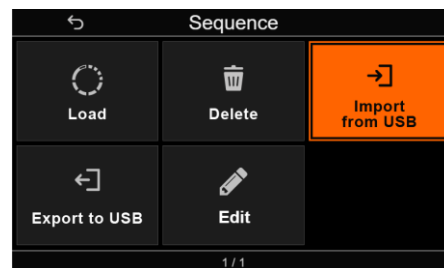

Note

Example: The CSV file format of PSW for SAS. (PHU supports this format)

	A	B	C	D	E	F	G	H	I	J	K	L	M
1	memo	SAS Example.											
2													
3	DisplayItem	V1											
4													
5	CycleItem	Number	Start Step	End Step									
6	Cycle	2	3	8									
7													
8	Partes	SAS											
9													
10	Step	Point	Output	Time(sec)	Voc(V)	Vamp(V)	Isc(A)	Isp(A)	CV(FV)	CC(FIA)	IV Mode	MargIn(%)	
11	1	On		10	40	32	10	9	MAX	MAX	CVHS	0	
12	2	On		10									
13	3	On		10									
14	4	On		10	40	32	7	6.3					
15	5	On		10									
16	6	On		10									
17	7	On		10	30	24	10	9					
18	8	On		10									
19	9	On		10									
20													

2-4-4. Run Sequence

Overview A Sequence can be run from one of ten memory slots.

- Steps**
1. Before a test script can be run, it must first be loaded into one of the 10 memory save slots.
 2. Configure SEQ to 1 to 10 (save memory slot no. to run)

Range SEQ 1 to 10

3. Press the Menu key to go to the Sequence page. Choose the “Load” icon in this page.

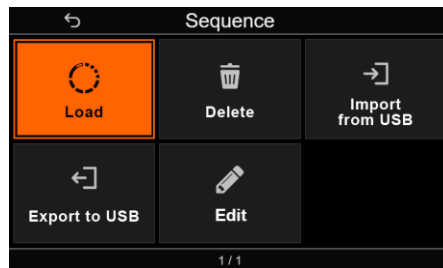
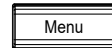

4. Users can choose the Sequence that they want to load. (In SEQ1 to SEQ10, the icon next to “File” indicates that there is data. If the icon is not present, it means there is no data.)



5. The Sequence type will be displayed when completed. At this point, the bottom left corner of the screen will change to the appearance shown in the image. (The image is for reference.)

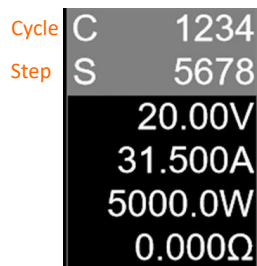

6. Press the Output button on the front panel, and the Sequence will automatically start to run.

Note Error messages: If you try to run a Sequence from an empty memory location, a window will pop up at this time to remind “no data”.

Stop a Sequence

To stop (abort) a running Sequence at any time, press the Output button on the front panel. Users can press the ESC button to exit Sequence type and the display will return to the Load SEQ page.

2-4-5. Export Sequence to USB

Overview

The Export Sequence function saves a test file to the root directory of a USB flash drive.

- Files will be saved as tXXX.tst where XXX is the memory number 001~010 from which the SEQ was exported from.
- Files of the same name on the USB flash drive will be written over.

Steps

1. Insert a USB flash drive into the front panel USB-A slot.

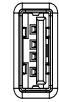

2. Press the Menu button and choose the “Function” icon.

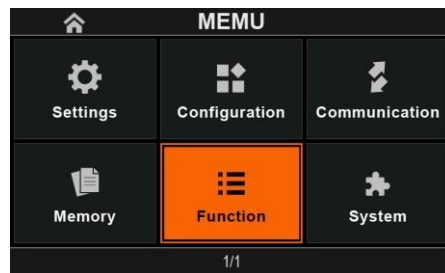
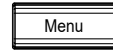

3. Choose the “Sequence” icon in the Function page.

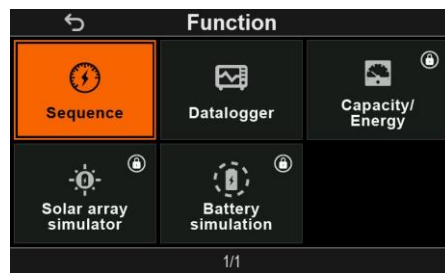

4. Choose the “Export to USB” icon in the Sequence page.





If the USB drive is not recognized, check to see the block of interface state. If not, reinsert the USB flash drive. (The image is for reference.)

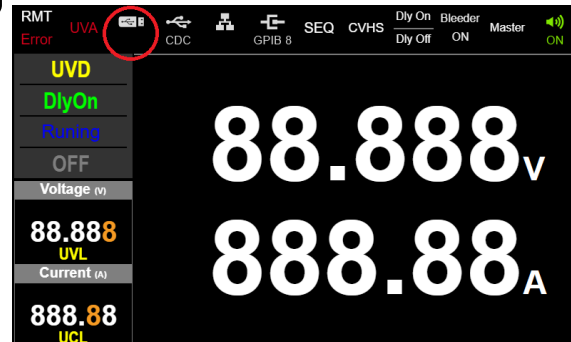

2-4-6. Delete Sequence

Overview The Delete Sequence function will delete a SEQ from the internal memory.

Steps 1. Choose the “Delete” icon in the Sequence page to remove from the internal memory.

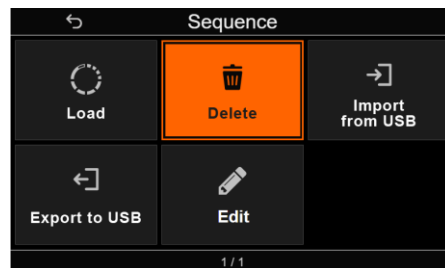

2. Choose the SEQ that you want to remove. The SEQ will be removed from the internal memory.

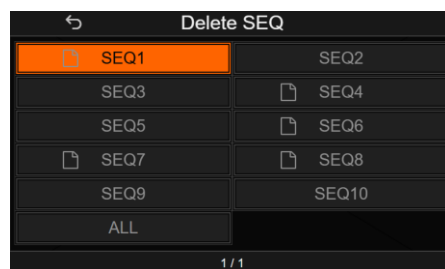

Note Error messages: If you try to remove a SEQ from an empty memory location, a window will pop up at this time to remind “no data”.

2-4-7. Edit Sequence

Overview The user can use the “Edit Sequence” function to set the step parameters.

Steps 1. Press the Menu button and choose the “Function” icon.

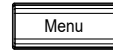

2. Choose the “Sequence” icon in the Function page.

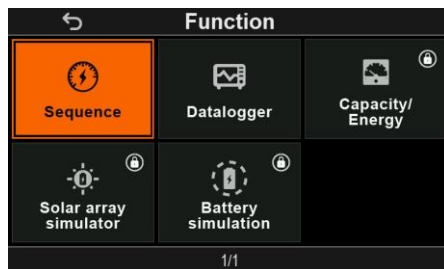

3. Choose the “Edit” icon in the Sequence page.

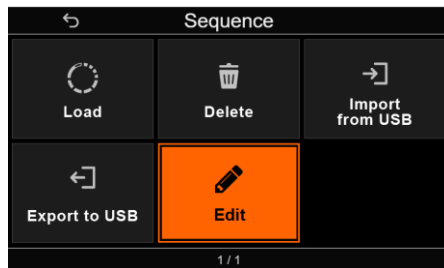

4. For example, choose the “SEQ1” in “Edit SEQ” page.



- In the "Edit SEQ1" page, use the Current Knob to move the Step cursor (blue box). Use the Voltage Knob to move the function options (orange), such as [Cycle] <=> [Save] <=> [Edit] <=> [Insert] <=> [Delete].



- Press the Current Knob to bring up the "Jump to Step" dialog box, allowing you to immediately jump to the entered Step.

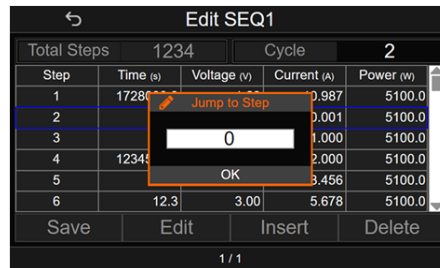

- In the "Jump to Step" dialog box, pressing the Voltage Knob will directly jump to "Edit".

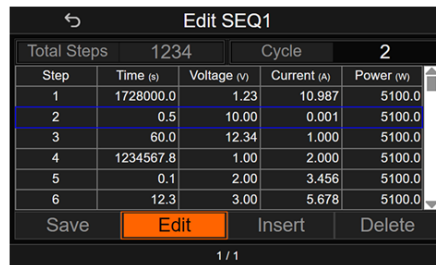

- In the "Edit SEQ1" menu, rotate the Voltage Knob to "Save" and press the Voltage Knob.

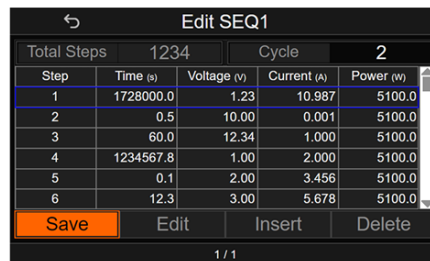

9. The message box “Access ...” will appear, analyzing the entire sequence process. Since the editing is done locally, it only needs to check if “Loop” and “Endloop” are paired correctly and ensure there are no recursions. If everything is correct, the data will be saved, and the message box will close.

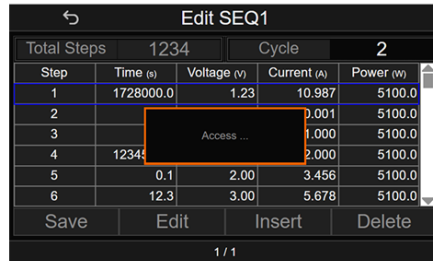

10. If “Loop” and “Endloop” are not paired correctly or if there is recursion, a dialog box will be displayed.



11. In the “Edit SEQ1” menu, rotate the Voltage Knob to “Edit” and press the Voltage Knob. This will enter the “Edit SEQ1 / Step1” first page setting menu.

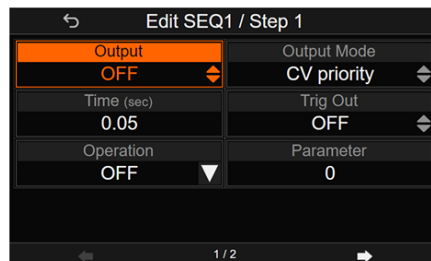

Output: Control Output OFF and Output ON.



Output Mode: When Output ON, output with “CV priority” or “CC priority”.



Time (sec): Set the duration for this step to execute, ranging from 0.05 seconds to 20 days. Setting it to 0 means infinite (displayed as INFINITY).

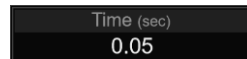

24 hours = 86,400.00 sec

20 days = 1,728,000.00 sec

Trig Out: Sets whether to generate a Trig Out signal. Output IO pin, see Digital IO Settings on page 85.



Operation and Parameter: Special function operation.

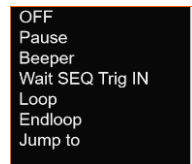

- **Pause:**
The sequence pauses until the “Current” button is pressed or the “continue” command is received.
- **Beeper:**
The buzzer sounds. In the Parameter, 0 means OFF, and 1 means ON.
- **Wait SEQ Trig IN:**
Waits until the “PROG TRIG IN” signal is received from the Digital I/O.(See page 85)
- **Loop:**
Starts a loop, used in conjunction with Endloop.
The Parameter specifies the number of loop iterations.
- **Endloop:**
Ends the loop, used in conjunction with Loop.
- **Jump to:**
Jumps to a specified Step. The Parameter is the target Step.

12. When the Voltage Knob is rotated to “Parameter” and then turned clockwise, it will enter the “Edit SEQ1/ Step1” second page setting menu.

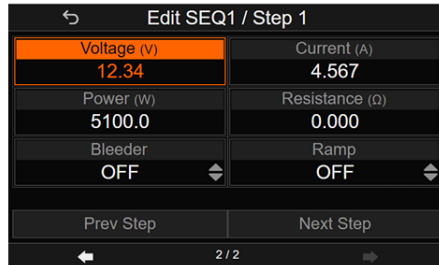

Voltage: Set the voltage value.

Current: Set the current value.

Power: Set the power value.

Resistance: Set the internal resistance value.

Bleeder: Set the Bleeder resistor control method.



Ramp: Set whether the transition from the previous step to the next step is immediate or with a slope.



Prev Step: Switch to the previous step.

Next Step: Switch to the next step.

13. When the Voltage Knob is rotated to “Ramp” and then rotated clockwise, it will enter the menu “Edit SEQ1/Step1” on the third-page settings.

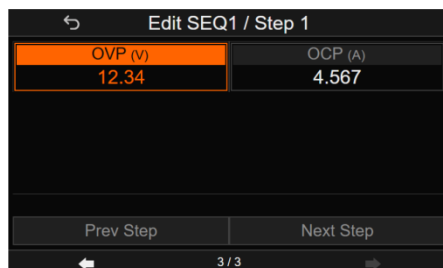

OVP: Set the over-voltage protection value.

OCP: Set the over-current protection value.

3. CONFIGURATION

3-1. Menu Overview

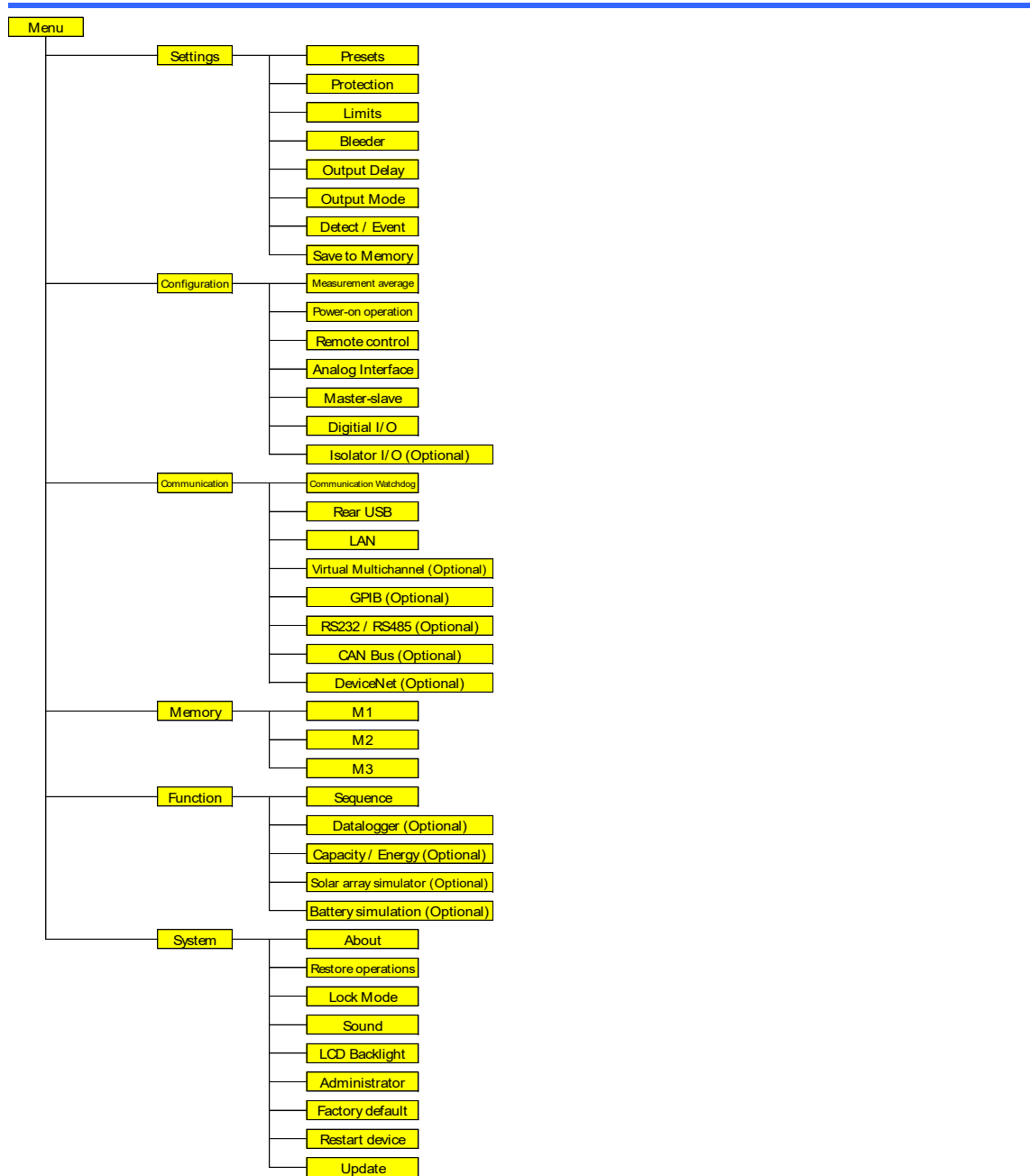

Menu of the PHU power supplies is divided into six different settings: Normal setting, Normal configuration, Communication, Memory, Function, and System.

The settings can be changed when the unit is already on. This prevents some important configuration parameters from being changed inadvertently. Here is the menu tree below.

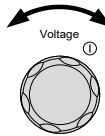
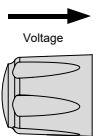

1st	2nd	3rd
Settings	Presets	Vset, Iset, Pset, Rset
	Protection	OVP OVP Delay, OCP OCP Delay, OPP OPP Delay
	Limits	UVL, OVL, UCL, OCL, OP, ORL
	Bleeder	ON, OFF, Auto
	Output Delay	ON delay time, OFF delay time
	Output Mode	CVHS, CVLS, CCHS, CCLS, VSR, ISR
	Detect/Event	UVD, OVD, UCD, OCD, OPD
	Save to Memory	M1, M2, M3
Configuration	Measurement average	Low, Middle, High
	Power-on operation	Display, Output sate, Memory
	Remote control	Not allowed, Allows
	Analog Interface	V-control, I-control, P-control, R-control, REM-OUT control
	Master-slave	Single, Master, Slave
	Digital I/O	Default, View, Function, Polarity
Communication	Isolator I/O(Optional)	
	Watchdog	
	Rear USB	CDC, TMC
	LAN	IP, MAC, Web, Port, TCP
	VMC (Optional)	Domain number, Channel number
	GPIB (Optional)	Address
	RS232/485 (Optional)	Baud rate, RS485 Address

Settings	M1	View, Load, Import, Export
	M2	View, Load, Import, Export
	M3	View, Load, Import, Export
Configuration	Sequence	Load, Delete, Import, Export, Edit
	Datalogger(Optional)	
	AH/WH Meter(Optional)	
	SAS(Optional)	
System	Battery Simulation(Optional)	
	About	Model, SN, OS version, SW version, FW version
	Restore	Safe, Auto
	Lock Mode	Allow output off or Allow output on/off
	Sound	Key sound, Alarm sound
	LCD backlight	Deactivated, Activates, Brightness adjust
	Administrator	
	Factory default	
	Restart device	
Update		

- | | | |
|-------|--|--|
| Steps | <ol style="list-style-type: none"> 1. Press the “Menu” button on the panel. 2. Rotate the voltage knob to choose which setting you want to set. 3. Press the voltage knob to enter the exclusive page. 4. Among the parameters, some can be adjusted using the numeric keypad, while others are selected through the voltage knob. 5. Once the settings are complete, you can press the “ESC” key to return to the previous page. | 

 |
|-------|--|--|

(You can refer to page 37, where detailed examples are provided.)

Some functions and quick settings can be accessed through the buttons on the panel. For details, please refer to page 5. (Front Panel)

3-2. Menu Table

Please use the listed below when applying the various settings.

Normal Settings	Path	Content/Setting Range
Internal resistance setting	Menu/ Setting/ Presets	(0.000 to 0.471) Ω(PHU-502L80)
		(0.000 to 2.857) Ω(PHU-502L200)
		(0.00 to 16.67) Ω(PHU-502M500)
		(0.00 to 37.50) Ω(PHU-502M750)
		(0.0 to 66.7) Ω(PHU-502H1000)
		(0.0 to 150.0) Ω(PHU-502H1500)
		(0.000 to 0.235) Ω(PHU-103L80)
		(0.000 to 1.428) Ω(PHU-103L200)
		(0.00 to 8.33) Ω(PHU-103M500)
		(0.00 to 18.75) Ω(PHU-103M750)
		(0.00 to 33.33) Ω(PHU-103H1000)
		(0.0 to 75.0) Ω(PHU-103H1500)
		(0.000 to 0.157) Ω(PHU-153L80)
		(0.00 to 0.95) Ω(PHU-153L200)
		(0.00 to 5.56) Ω(PHU-153M500)
		(0.00 to 12.50) Ω(PHU-153M750)
(0.00 to 22.22) Ω(PHU-153H1000)		
(0.0 to 50.0) Ω(PHU-153H1500)		
OVP,OPP,OVP	Menu/ Settings/ Protection	Refer to page 39
OVP Delay Time	Menu/ Settings/ Protection	0.1 sec to 2.0 sec(PHU-502L80, 200-70, 500-30) 0.0 sec to 2.0 sec(other series)
OCP Delay Time	Menu/ Settings/ Protection	0.1 sec to 2.0 sec
OPP Delay Time	Menu/ Settings/ Protection	0.1 sec to 2.0 sec

Voltage Setting Limit (UVL & OVL)	Menu/ Settings / Limits	(0.00 to 84.00) V(PHU-502L80)
		(0.00 to 210.00) V(PHU-502L200)
		(0.00 to 525.00) V(PHU-502M500)
		(0.0 to 787.5) V(PHU-502M750)
		(0.0 to 1050.0) V(PHU-502H1000)
		(0.0 to 1575.0) V(PHU-502H1500)
		(0.00 to 84.00) V(PHU-103L80)
		(0.00 to 210.00) V(PHU-103L200)
		(0.00 to 525.00) V(PHU-103M500)
		(0.0 to 787.5) V(PHU-103M750)
		(0.0 to 1050.0) V(PHU-103H1000)
		(0.0 to 1575.0) V(PHU-103H1500)
		(0.00 to 84.00) V(PHU-153L80)
		(0.00 to 210.00) V(PHU-153L200)
		(0.00 to 525.00) V(PHU-153M500)
		(0.0 to 787.5) V(PHU-153M750)
(0.0 to 1050.0) V(PHU-153H1000)		
(0.0 to 1575.0) V(PHU-153H1500)		
Current Setting Limit (UCL & OCL)	Menu/ Settings / Limits	(0.00 to 178.50) A(PHU-502L80)
		(0.00 to 73.50) A(PHU-502L200)
		(0.000 to 31.500) A(PHU-502M500)
		(0.000 to 21.000) A(PHU-502M750)
		(0.000 to 15.750) A(PHU-502H1000)
		(0.000 to 10.500) A(PHU-502H1500)
		(0.00 to 357.00) A(PHU-103L80)
		(0.00 to 147.00) A(PHU-103L200)
		(0.00 to 63.30) A(PHU-103M500)
		(0.000 to 42.000) A(PHU-103M750)
		(0.000 to 31.500) A(PHU-103H1000)
		(0.000 to 21.000) A(PHU-103H1500)
		(0.00 to 535.50) A(PHU-153L80)
		(0.00 to 220.50) A(PHU-153L200)
		(0.00 to 94.50) A(PHU-153M500)
		(0.00 to 63.00) A(PHU-153M750)
(0.000 to 47.250) A(PHU-153H1000)		
(0.000 to 31.500) A(PHU-153H1500)		

Power Setting Limit (OPL)	Menu/ Settings / Limits	(0 to 5100) W(PHU-502L80) (0 to 5100) W(PHU-502L200) (0 to 5100) W(PHU-502M500) (0 to 5100) W(PHU-502M750) (0 to 5100) W(PHU-502H1000) (0 to 5100) W(PHU-502H1500) (0 to 10200) W(PHU-103L80) (0 to 10200) W(PHU-103L200) (0 to 10200) W(PHU-103M500) (0 to 10200) W(PHU-103M750) (0 to 10200) W(PHU-103H1000) (0 to 10200) W(PHU-103H1500) (0 to 15300) W(PHU-153L80) (0 to 15300) W(PHU-153L200) (0 to 15300) W(PHU-153M500) (0 to 15300) W(PHU-153M750) (0 to 15300) W(PHU-153H1000) (0 to 15300) W(PHU-153H1500)
Resistance Setting Limit(ORL)	Menu/ Settings / Limits	(0 to 0.4706) Ω (PHU-502L80) (0 to 2.8571) Ω (PHU-502L200) (0 to 16.667) Ω (PHU-502M500) (0 to 37.5) Ω (PHU-502M750) (0 to 66.6667) Ω (PHU-502H1000) (0 to 150) Ω (PHU-502H1500) (0 to 0.2352) Ω (PHU-103L80) (0 to 1.4286) Ω (PHU-103L200) (0 to 8.3333) Ω (PHU-103M500) (0 to 18.75) Ω (PHU-103M750) (0 to 33.3333) Ω (PHU-103H1000) (0 to 75) Ω (PHU-103H1500) (0 to 0.1569) Ω (PHU-153L80) (0 to 0.9524) Ω (PHU-153L200) (0 to 5.5556) Ω (PHU-153M500) (0 to 12.5) Ω (PHU-153M750) (0 to 22.2222) Ω (PHU-153H1000) (0 to 50) Ω (PHU-153H1500)
Bleeder circuit control	Menu/ Setting / Bleeder	ON/OFF/AUTO (Page 43)
Output ON delay time	Menu/ Setting / Output Delay	Delays turning the output on for a designated amount of time. 0.00 sec to 99.99 sec
Output OFF delay time	Menu/ Setting / Output Delay	Delays turning the output off for a designated amount of time. 0.00s to 99.99s

Output mode select	Menu/ Setting / Output Mode	<p>Selects High Speed Priority or Slew Rate Priority for CV or CC mode. The voltage or current slew rate can only be edited if CC/CV Slew Rate Priority is selected.</p> <p>CV high speed priority (CVHS) CC high speed priority (CCHS) CV slew rate priority (CVLS) CC slew rate priority (CCLS)</p>
Rising/ Falling voltage slew rate	Menu/ Setting / Output Mode	<p>Sets the rising/Falling voltage slew rate. Only applicable if Output Mode is set to CV Slew Rate Priority.</p> <p>(0.01 to 160.00) V/sec (PHU-502L80) (0.01 to 400.00) V/sec (PHU-502L200) (0.1 to 1000.0) V/sec (PHU-502M500) (0.1 to 1500.0) V/sec (PHU-502M750) (0.1 to 2000.0) V/sec (PHU-502H1000) (0.1 to 3000.0) V/sec (PHU-502H1500) (0.01 to 160.0) V/sec (PHU-103L80) (0.01 to 400.00) V/sec (PHU-103L200) (0.1 to 1000.0) V/sec (PHU-103M500) (0.1 to 1500.0) V/sec (PHU-103M750) (0.1 to 2000.0) V/sec (PHU-103H1000) (0.1 to 3000.0) V/sec (PHU-103H1500) (0.01 to 160.0) V/sec (PHU-153L80) (0.01 to 400.00) V/sec (PHU-153L200) (0.1 to 1000.0) V/sec (PHU-153M500) (0.1 to 1500.0) V/sec (PHU-153M750) (0.1 to 2000.0) V/sec (PHU-153H1000) (0.1 to 3000.0) V/sec (PHU-153H1500)</p>
Rising/Falling current slew rate	Menu/ Setting/ Output Mode	<p>Sets the rising/Falling current slew rate. Only applicable if Output Mode is set to CC Slew Rate Priority.</p> <p>(0.01 to 340.00) A/sec (PHU-502L80) (0.01 to 140.00) A/sec (PHU-502L200) (0.001 to 60.000) A/sec (PHU-502M500) (0.001 to 40.000) A/sec (PHU-502M750) (0.001 to 30.00) A/sec (PHU-502H1000) (0.001 to 20.00) A/sec (PHU-502H1500) (0.1 to 680.0) A/sec (PHU-103L80) (0.01 to 280.00) A/sec (PHU-103L200) (0.01 to 120.0) A/sec (PHU-103M500) (0.01 to 80.0) A/sec (PHU-103M750) (0.001 to 60.00) A/sec (PHU-103H1000) (0.001 to 40.00) A/sec (PHU-103H1500) (0.01 to 160.0) A/sec (PHU-153L80) (0.01 to 400.00) A/sec (PHU-153L200) (0.01 to 180.00) A/sec (PHU-153M500) (0.01 to 120.00) A/sec (PHU-153M750) (0.01 to 90.00) A/sec (PHU-153H1000)</p>

		(0.001 to 60.00) A/sec (PHU-153H1500)
Under voltage Detection	Menu/ Setting/ Detect/Event	<p>UVD Action:</p> <p>NONE/ SIGNAL/</p> <p>(It will be displayed in the block of detect state when a UVD occurs)</p> <p>WARNING /</p> <p>(When a UVD occurs, a window alert will appear).</p> <p>ALARM</p> <p>(When a UVD occurs, a window alert will appear, it will be displayed in the block of protection state, and the output will be automatically turned off.)</p>
Over voltage Detection	Menu/ Setting/ Detect/Event	<p>OVD Action:</p> <p>NONE/ SIGNAL/</p> <p>(It will be displayed in the block of detect state when a OVD occurs)</p> <p>WARNING/</p> <p>(When an OVD occurs, a window alert will appear).</p> <p>ALARM</p> <p>(When an OVD occurs, a window alert will appear, it will be displayed in the block of protection state, and the output will be automatically turned off.)</p>
Under current Detection	Menu/ Setting/ Detect/Event	<p>UCD Action:</p> <p>NONE/ SIGNAL/</p> <p>(It will be displayed in the block of detect state when a UCD occurs)</p> <p>WARNING/</p> <p>(When a UCD occurs, a window alert will appear).</p> <p>ALARM</p> <p>(When a UCD occurs, a window alert will appear, it will be displayed in the block of protection state, and the output will be automatically turned off).</p>

		OCD Action: NONE/ SIGNAL/ (It will be displayed in the block of detect state when a OCD occurs)
Over current Detection	Menu/ Setting/ Detect/ Event	WARNING/ (When an OCD occurs, a window alert will appear). ALARM (When an OCD occurs, a window alert will appear, it will be displayed in the block of protection state, and the output will be automatically turned off).
		OPD Action: NONE/ SIGNAL/ (It will be displayed in the block of detect state when a OPD occurs)
Over power Detection	Menu/ Setting/ Detect/ Event	WARNING/ (When an OPD occurs, a window alert will appear). ALARM (When an OPD occurs, a window alert will appear, it will be displayed in the block of protection state, and the output will be automatically turned off).
Memory save	Menu/ Settings/ Save to memory	M1, M2, M3
Normal Configuration	Path	Content/Setting Range
Measurement Average Setting	Menu/ configuration/ Measurement Average	Determines the level of smoothing for the average setting. Low/Middle/High
Specifies how the panel is displayed at power-on.	Menu/ Configuration/ Power-on Operation	Voltage Current Voltage Current Power Voltage Power Current Power Voltage Current Bar Voltage Current Power Bar

Configure the output state after power-on.	Menu/ Configuration/ Power-on Operation	ON OFF LAST (LAST: The state when it was last turned off)
Configures the power supply to perform one of the following actions after power-on.	Menu/ Configuration/ Power-on Operation	None Load the M1/M2/M3 Load the SEQ1/2/3/4/5/6/7/8/9/10
Allows remote control of the device via digital or analog interface.	Menu/ Configuration/ Remote control	Not allowed/Allows
Analog interface	Menu/ Configuration/ Analog interface	voltage, current, power, resistance, REM-OUT control(Multiple choice)
Selects the voltage range for the analog set values, actual values and reference voltage output.	Menu/ Configuration/ Analog interface	0V to 5V/0V to 10V
Selects how the input pin REM-OUT of the analog interface shall be working regarding levels and logic.	Menu/ Configuration/ Analog interface	High ON/Low ON
Master/Slave Configuration	Menu/ Configuration/Master-Slave	single Master: total power Slave: address
Digital I/O	Menu/ Configuration/ Digital I/O	default, view, function, polarity (For detailed information, please refer to page 85)
Communication	Path	Content/Setting Range
watchdog	Menu/ Communication/ Watchdog	During remote control, if there is no communication beyond the time set by the watchdog, an alarm will be issued and the output will be turned off. Range: 0 to 65535 (0 = deactivated)
Setup rear USB	Menu/ Communication/Rear USB	Device Mode: Disable, USB-CDC,USB-CDC(Full speed),USB-TMC,USB-TMC(Full speed), Host

LAN: IP allocation Settings	Menu/ Communication/LAN/ Edit	Manual, DHCP
LAN: IP address Settings	Menu/ Communication/LAN/ Edit	(0 to 255). (0 to 255). (0 to 255). (0 to 255)
LAN: Gateway Settings	Menu/ Communication/LAN/ Edit	(0 to 255). (0 to 255). (0 to 255). (0 to 255)
LAN: Subnet mask Settings	Menu/ Communication/LAN/ Edit	(0 to 255). (0 to 255). (0 to 255). (0 to 255)
LAN: DNS Address Settings	Menu/ Communication/LAN/ Edit	(0 to 255).(0 to 255).(0 to 255).(0 to 255)
LAN: Port Settings	Menu/ Communication/LAN/ Edit	
LAN: Web control	Menu/ Communication/LAN/ Edit	Enable, Disable
LAN: Host name Settings	Menu/ Communication/LAN/ Edit	Users can use the virtual keyboard (use voltage knob to control)
LAN: Web password Settings	Menu/ Communication/LAN/ Edit	Users can use the virtual keyboard (use voltage knob to control)
LAN: Domain name Settings	Menu/ Communication/LAN/ Edit	Users can use the virtual keyboard (use voltage knob to control)
LAN: TCP keep-alive Settings	Menu/ Communication/LAN/ Edit	Enable, Disable
Virtual Multichannel Settings(optional): Domain number Settings	Menu/ Communication/Virtual Multichannel	0 The multichannel function is not used (factory default setting). 1 to 254 The domain number when the multichannel function is used.

Virtual Multichannel Settings(optional):	Menu/ Communication/Virtual Multichannel	0 Master unit on the multichannel network (factory default setting). 1 to 30 Channel number of the slave unit on the multichannel network.
GPIB (optional):	Menu/ Communication/GPIB	Address : 1 to 30
RS232/RS485 (optional):	Menu/ Communication/RS232/R S485	2400, 4800, 9600, 19200, 38400, 57600, 115200
Baud rate Settings		
RS485 Address Settings(optional):	Menu/ Communication/RS232/R S485	0 to 31
Can Bus (optional):	Menu/ Communication/Can Bus	Auto, LSS, 10kbps, 20kbps, 50kbps, 100kbps, 125kbps, 250kbps, 500kbps, 800kbps, 1Mbps
Baud rate Settings		
Can Bus (optional):	Menu/ Communication/Can Bus	1 to 127
Node Address Settings		
DeviceNet (optional):	Menu/ Communication/ DeviceNet	125kbps, 250kbps, 500kbps
Baud rate Settings		
DeviceNet (optional):	Menu/ Communication/ DeviceNet	0 to 63
MAC ID Settings		
Memory	Path	Content/Setting Range
Memory parameter (M1, M2, M3)	Menu/ Memory	View, Load, Import from USB, Export to USB
Function	Path	Content/Setting Range
Sequence	Menu/ Function/ Sequence	Load, Delete, Import from USB, Export to USB, Edit
System	Path	Content/Setting Range
About	Menu/ System/ About	Module, Serial Number, OS version, SW version, FW version

Action when recovering from AC-FAIL protection.	Menu/ System/ Restore operations	Safe: The alarm status is cleared after the problem that caused the alarm is fixed. Auto: The alarm status is cleared after the problem that caused the alarm is fixed, and returns to the status before the alarm occurs.
AC Power Recovery	Menu/ System/ Restore operations	The AC Power Recovery setting can only take effect when the device is disconnected to the power supply, the built-in power in the device has been completely released, and the device is reconnected to a power supply. Power OFF/ Power ON/ Last State/
Lock Mode	Menu/ System/ Lock Mode	When the front panel is locked, the Lock Mode function determines the behavior of the Output key. Allow output to turn off/ Allows to turn on/off output.
Buzzer ON/OFF control	Menu/ System/ Sound	Key sound:(Deactivates/activates) Alarm sound:(Deactivates/activates)
Backlight off after 60s	Menu/ System/ LCD Backlight	Deactivates/activates
Brightness adjust	Menu/ System/ LCD Backlight	(0 to 100) %
Administrator	Menu/ System/ Administrator	The device "Administrator" mode grants access to advanced settings and management features, password required.
Factory Default	Menu/ System/ Factory Default	ESC/ Reset
Reboots the instrument to its power-on state.	Menu/ System/ Restart Device	ESC/ Reset
Update	Menu/ System/ Update	

3-3. Additional information

Note	The Output ON/OFF Delay Time setting has a maximum deviation (error) of 20 ms.
Note	When the PHU DC OUTPUT is in progress, if the user presses the MENU button, they can view the configured parameters.
Rising/Falling Voltage Slew Rate	Sets the rising & falling voltage slew rate. Only applicable if Output Mode is set to CV Slew Rate Priority.
Rising/Falling Current Slew Rate	Sets the rising & falling current slew rate. Only applicable if Output Mode is set to CC Slew Rate Priority.
Internal Resistance Settings	Sets the internal resistance of the power supply. 0.000 Ω to X.XXX Ω (Where X.XXX = Rating Voltage/Rating Current)
Display Memory Parameter	Displays which memory setting is recalled (M1,M2 or M3) when recalling a setup.

4. Digital I/O Configuration

Introduction The PHU's Digital I/O port includes a total of 7 input/output pins and one ground pin. These 7 pins can be individually configured as either inputs or outputs based on user settings. By default, these 7 pins are set to a static voltage of 5V output. When configured as inputs, the pins can be triggered by shorting them to ground. When configured as outputs, the voltage level of each pin will be either 5V or 0V (relative to ground), depending on the PHU's status. Additionally, the polarity (positive or negative) of these 7 pins can be adjusted through configuration settings.

Digital I/O interface

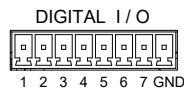

Panel operation 1. Press the menu button and enter the “Configuration” icon.

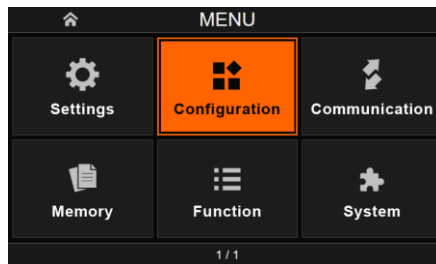
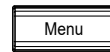

2. Choose the “Digital IO” in the Configuration page.

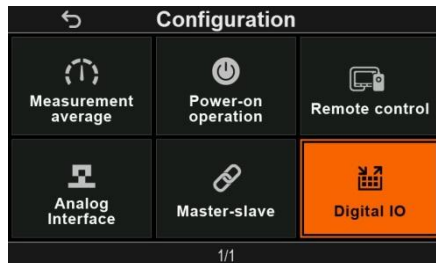

3. You can see there are four options in the Digital IO page.

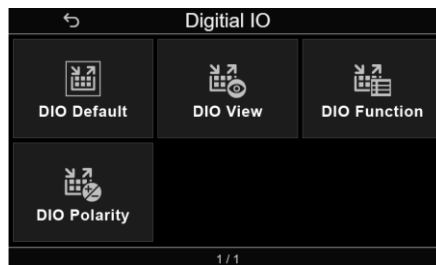

- Select DIO Default option to configure the DIO to the factory default settings.



- Select DIO View option to see the DIO1 to DIO7 settings.



- Select DIO Function option to set the DIO1 to DIO7 settings.



Input mode Output OFF, Output ON, Output Control, Clear Alarm, Load M1, Load M2, Load M3, PROG TRIG IN

Output mode Output State, Power ON, Power Fault , OVP, OCP, OPP, UVD, OVD, UCD, OCD, OPD, Alarm state, PROG TRIG IN

For details about PROG TRIG IN and PROG TRIG OUT, see Edit Sequence on page 66.

Alarm state PUF 1 to 6, FAN Fail 1 to 3, OTP, LLF, SLF, MSP

The Input mode is unique. For example, when DIO 1 is set to Output OFF, DIO 2 to DIO 6 cannot be set to Output OFF.

When the Output OFF signal is activated, the Output OFF signal takes priority over the Output ON signal, the Output Control signal, and the Output button operation on the front panel.

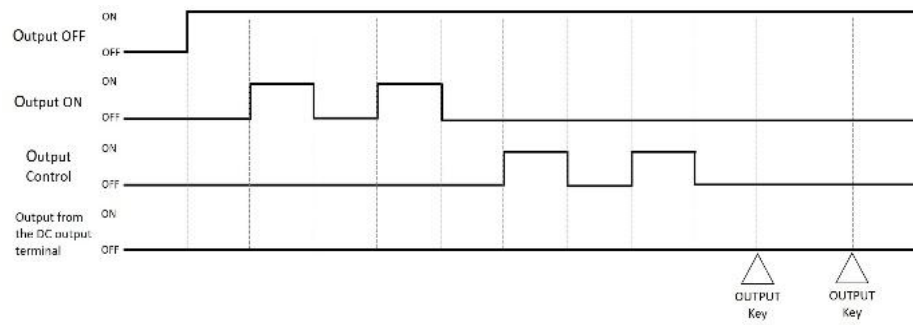

When the Output OFF signal is turned off, the relationship between the Output ON signal and the Output button operation is as follows.

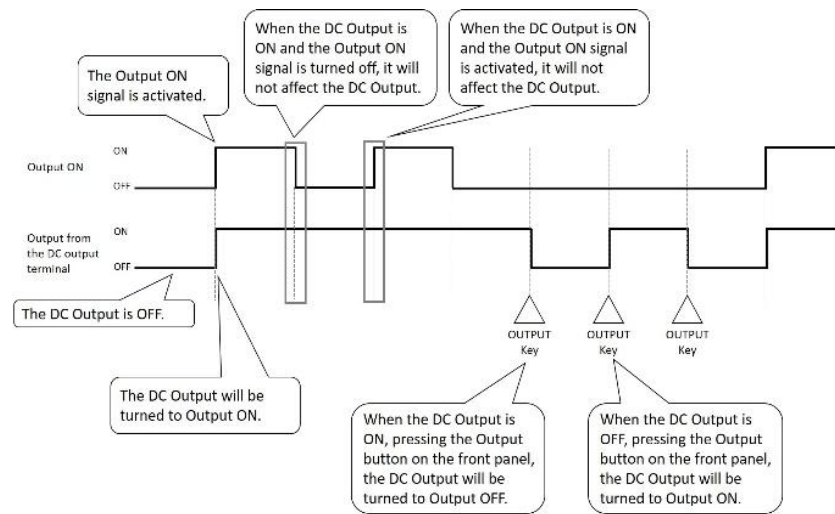

When the Output OFF signal is turned off, the relationship between the Output Control signal and the Output button operation is as follows.

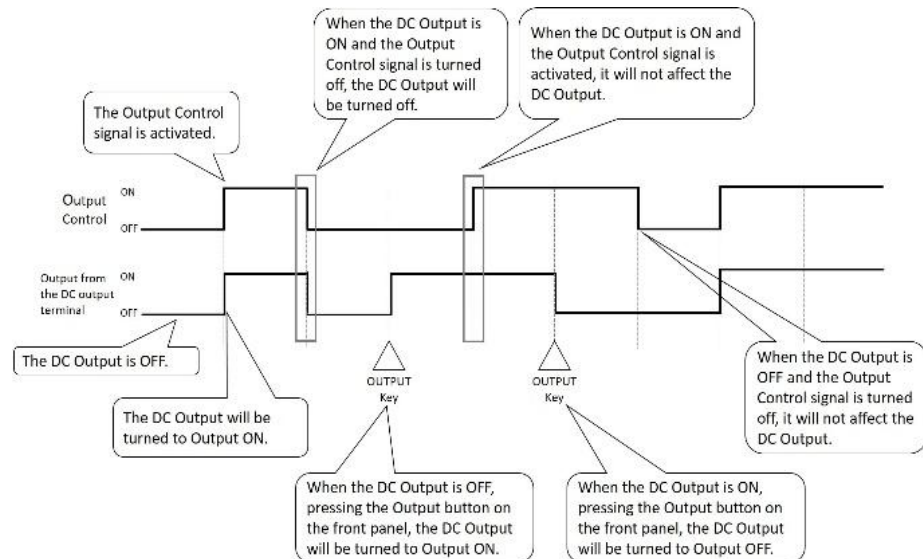

When the Output OFF signal is turned off, the relationship between the Output ON signal and the Output Control signal is as follows.

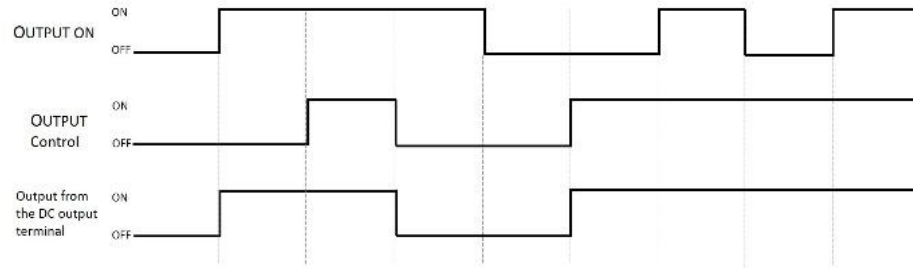

7. Select DIO Polarity option to set the Polarity of DIO 1 to DIO 7 as Positive or Negative. (Positive means a logical true signal is a voltage high at the pin. Negative means a logical true signal is a voltage low at the pin)

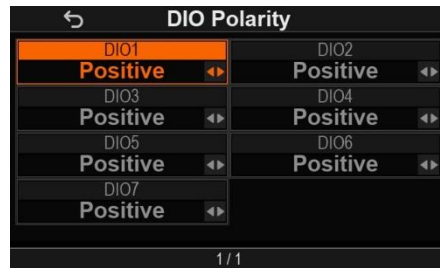

5. ANALOG CONTROL

The Analog Control chapter describes how to control the voltage or current output using an external voltage or resistance, monitor the voltage or current output as well as remotely turning off the output or shutting down the power supply.

5-1. Analog Remote Control Overview

The PHU power supply series have a number of analog control options. The Analog Control connectors are used to control output voltage and current using external voltage or resistance. The power supply output can also be controlled using external switches.

There is also an isolated analog control option. The Isolated analog connector is used to control the output voltage and current using an isolated external voltage or current source. Like the analog connector, it can also be used to monitor the current and voltage output as well.

5-1-1. Analog Control Connector Overview

Overview The Analog Control Connector is a 25 pin connector that can be used with the ARC (analog remote control) kit for wiring connections. The connector is used for all analog remote control.

The pins used determine what remote control mode is used

Pin Assignment

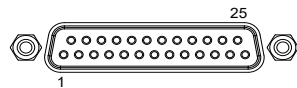

Pin name	Pin No.	Type & Description
EXT-V/R CV CONT	1	Analog_IN: This line uses an external voltage or resistance to control the output voltage. 0 V to 5 V or 0 V to 10 V; 0 % to 100 % of the rated output voltage.
EXT-V/R CC CONT	2	Analog_IN: This line uses an external voltage or resistance to control the output current. 0 V to 5 V or 0 V to 10 V; 0 % to 100 % of the rated output current.
EXT-V/R CP CONT	3	Analog_IN: This line uses an external voltage or resistance to control the output power. 0 V to 5 V or 0 V to 10 V; 0 % to 100 % of the rated output power.

EXT-V/R IN_R CONT	4	<p>Analog_IN:</p> <p>This line uses an external voltage or resistance to control the internal resistance.</p> <p>0 V to 5 V or 0 V to 10 V; 0 % to 100 % of the rated internal resistance.</p>
VREF	5	<p>Analog_OUT:</p> <p>This line provides 5V or 10V (depending on the setting) for use with external resistors.</p>
AGND	6	<p>Analog_GND:</p> <p>This is the common line for the external signal pins 1, 2, 3, 4, 5, 7, 8 and 9.</p>
V_MON	7	<p>Analog_OUT:</p> <p>Output voltage monitor.</p> <p>0 % to 100 % of the rated output voltage is generated as a voltage between 0 V and 5 V or a voltage between 0 V and 10 V when the output is ON.</p>
I_MON	8	<p>Analog_OUT:</p> <p>Output current monitor.</p> <p>0 % to 100 % of the rated output current is generated as a voltage between 0 V and 5 V or a voltage between 0 V and 10 V when the output is ON.</p>
P_MON	9	<p>Analog_OUT:</p> <p>Output power monitor.</p> <p>0 % to 100 % of the rated output power is generated as a voltage between 0 V and 5 V or a voltage between 0 V and 10 V when the output is ON.</p>
AGND	10	<p>Analog_GND:</p> <p>This is the common line for the external signal pins 1, 2, 3, 4, 5, 7, 8 and 9.</p>
ALM CLEAR	11	<p>Digital_IN:</p> <p>Alarm clear line.</p> <p>Alarms are cleared when a high level (+4.5 V to +5 V) signal is applied.</p>
Alarm Input	12	<p>Digital_IN:</p> <p>The output is turned off when a high level (+4.5 V to +5 V) signal is applied.</p>

OUT ON/OFF CONT	13	Digital_IN: When set to High = On, the output is turned on when input 5 V, the output is turned off when input 0 V. When Low = On, the output is turned on when input 0 V, the output is turned off when input 5 V.
ANALOG ENAB	14	Digital_IN: Analog function enables line. The Analog function is enable when a high level (+4.5 V to +5 V) signal is applied.
STATUS COM	15	Digital_GND: This is the common line for the external signal pins 11, 12, 13, 14, 17, 18, 19, 20, 21 and 22.
STATUS COM	16	Digital_GND: This is the common line for the external signal pins 11, 12, 13, 14, 17, 18, 19, 20, 21 and 22.
OUT ON STATUS	17	Digital_OUT: On when the output is on (open collector photocoupler output) ^{*1}
PWR ON STATUS	18	Digital_OUT: Outputs a low level signal when power is turned on. (open collector photocoupler output) ^{*1}
ALM STATUS	19	Digital_OUT: On when a protection function has been activated or when an output shutdown signal is being applied (open collector photocoupler output) ^{*1}
CV STATUS	20	Digital_OUT: This line is on when the PHU is in CV mode (photocoupler open collector output) ^{*1} .
CC STATUS	21	Digital_OUT: This line is on when the PHU is in CC mode (photocoupler open collector output) ^{*1} .
CP STATUS	22	Digital_OUT: This line is on when the PHU is in CP mode (photocoupler open collector output) ^{*1} .

STATUS COM	23	Digital_GND: This is the common line for the external signal pins 11, 12, 13, 14, 17, 18, 19, 20, 21 and 22.
AGND	24	Analog_GND: This is the common line for the external signal pins 1, 2, 3, 4, 5, 7, 8 and 9.
AGND	25	Analog_GND: This is the common line for the external signal pins 1, 2, 3, 4, 5, 7, 8 and 9.
Note*1	Open collector output: 30V max, 8mA max The common line for the status pins is floating (isolated voltage of 60 V or less). It is isolated from the control circuit.	
Note	The PIN14 is the Analog function enable line. When users using external signals to control the output parameters of the PHU, They needs to provide a high level voltage(+4.5 V to +5 V) at PIN14, relative to Digital_GND (PIN15, PIN16, PIN23). Otherwise, the external control functionality will not be available.	

5-1-2. External Voltage Control of Voltage Output

Background External voltage control of the voltage output is accomplished using the analog control connector on the rear panel. There are two external voltage control ranges, (0 to 5) V and (0 to 10) V, depending on the configuration.

For 0 V to 10 V:

Output voltage = full scale voltage x (external voltage/10)

For 0 V to 5 V:

Output voltage = full scale voltage x (external voltage/5)

(Setting Path: Menu/Configuration/Analog interface/page2)

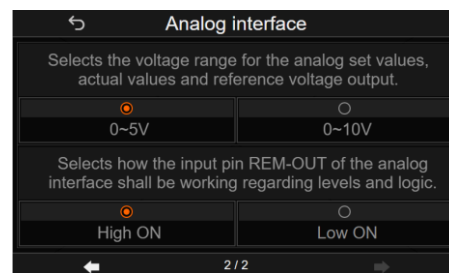

Connection When connecting the external voltage source to the analog connector, use shielded or twisted paired wiring.

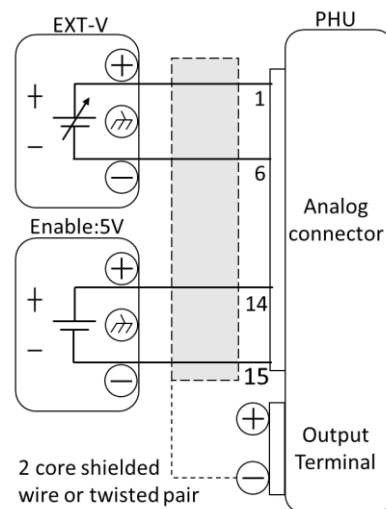

- Pin1 → EXT-V (+)
- Pin6 or Pin10 or Pin24 or Pin25 → EXT-V (-)
- Pin14 → Enable (+)
- Pin15 or Pin16 or Pin23 → Enable (-)
- Wire shield → negative (-) output terminal

Connection- shielding alt. If the wire shield needs to be grounded at the voltage source (EXT-V), then the shield cannot also be grounded at the negative (-) terminal output of the PHU power supply. This would short the output.

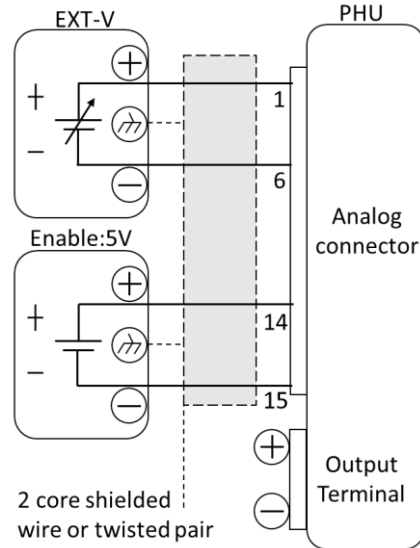

- Pin1 → EXT-V (+)
- Pin6 or Pin10 or Pin24 or Pin25 → EXT-V (-)
- Pin14 → Enable (+)
- Pin15 or Pin16 or Pin23 → Enable (-)
- Wire shield → EXT-V ground (GND)

Panel operation 1. Connect the external voltage according to the connection diagrams above.
2. Press the menu button and enter the “Configuration” icon.

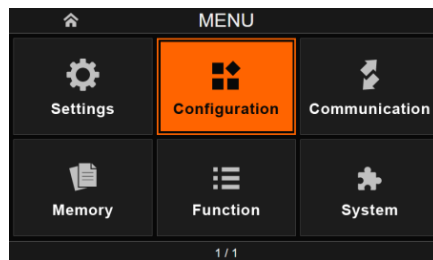

3. Choose the “Analog interface” in the Configuration page.



4. Check "Voltage control".



Note

Use a stable voltage supply for the external voltage control.



Ensure no more than 10.5 volts or 5.25 volts are input into the external voltage input.

Ensure the voltage polarity is correct when connecting the external voltage.

5-1-3. External Voltage Control of Current Output

Background

External voltage control of the current output is accomplished using the analog control connector on the rear panel. There are two external voltage control ranges, 0 V to 5 V and 0 V to 10V, depending on the configuration.

For 0 V to 10 V:

Output current = full scale current x (external voltage/10)

For 0 V to 5 V:

Output current = full scale current x (external voltage/5)

(Setting Path: Menu/Configuration/Analog interface/page2)

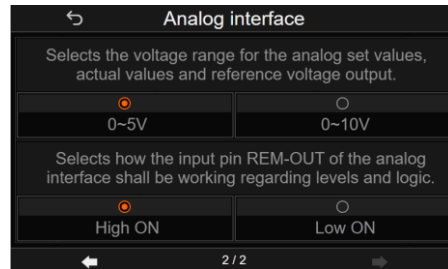

Connection

When connecting the external voltage source to the connectors, use shielded or twisted paired wiring.

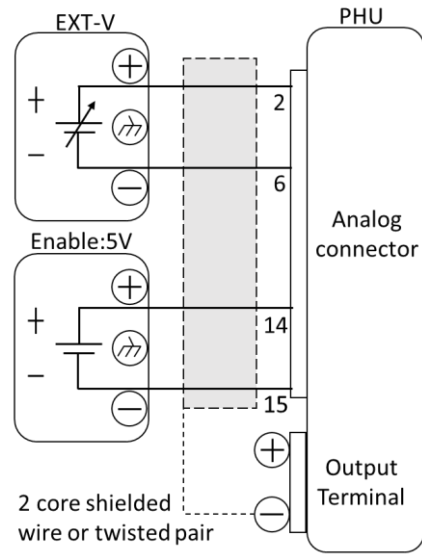

- Pin2 → EXT-V (+)
 - Pin6 or Pin10 or Pin24 or Pin25 → EXT-V (-)
 - Pin14 → Enable (+)
 - Pin15 or Pin16 or Pin23 → Enable (-)
 - Wire shield → negative (-) output terminal
-

Connection-shielding alt. If the wire shield needs to be grounded at the voltage source (EXT-V), then the shield cannot also be grounded at the negative (-) terminal output of the PHU power supply. This would short the output.

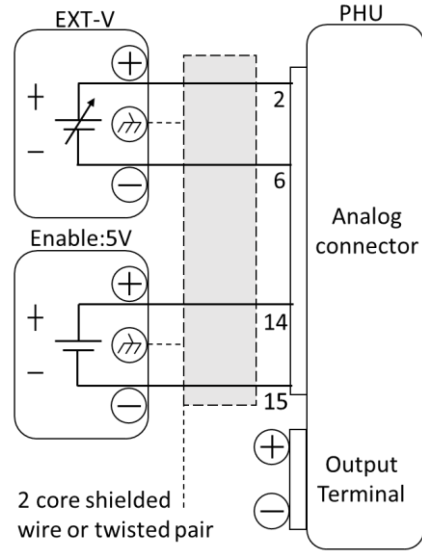

- Pin2 → EXT-V (+)
- Pin6 or Pin10 or Pin24 or Pin25 → EXT-V (-)
- Pin14 → Enable (+)
- Pin15 or Pin16 or Pin23 → Enable (-)
- Wire shield → EXT-V ground (GND)

Panel operation 1. Connect the external voltage according to the connection diagrams above.
 2. Press the menu button and enter the “Configuration” icon.

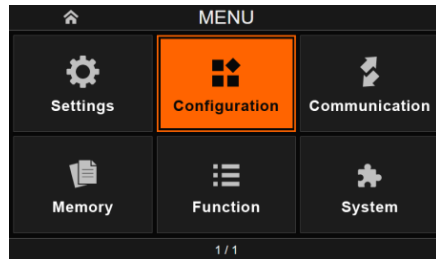

3. Choose the “Analog interface” in the Configuration page.

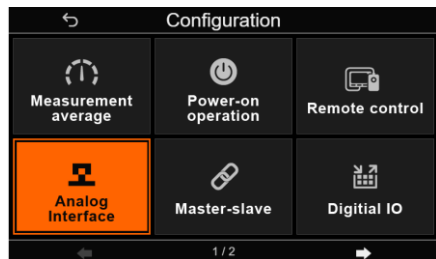

4. Check "Current control".



Note

Use a stable voltage supply for the external voltage control.



Ensure the voltage polarity is correct when connecting the external voltage.

Ensure no more than 10.5 volts or 5.25 volts are input into the external voltage input.

5-1-4. External Voltage Control of Power Output

Background

External voltage control of the power output is accomplished using the analog control connector on the rear panel. There are two external voltage control ranges, 0 V to 5 V and 0 V to 10V, depending on the configuration.

For 0 V to 10 V:

Output power = full scale power x (external voltage/10)

For 0 V to 5 V:

Output power = full scale power x (external voltage/5)

(Setting Path: Menu/Configuration/Analog interface/page2)

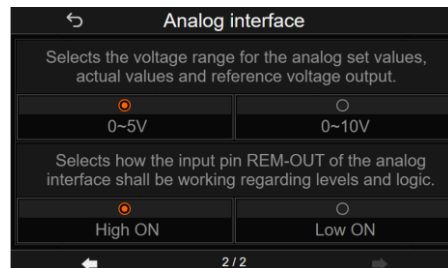

Connection

When connecting the external voltage source to the connectors, use shielded or twisted paired wiring.

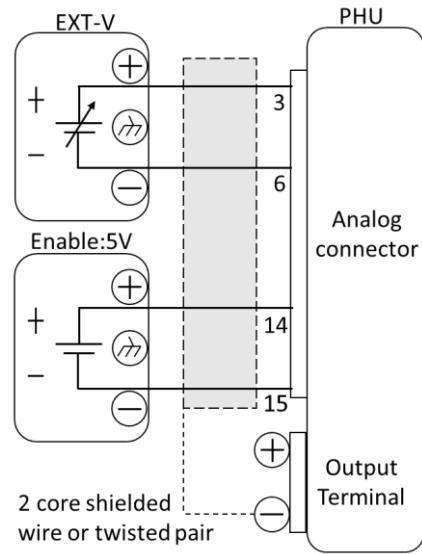

- Pin3 → EXT-V (+)
 - Pin6 or Pin10 or Pin24 or Pin25 → EXT-V (-)
 - Pin14 → Enable (+)
 - Pin15 or Pin16 or Pin23 → Enable (-)
 - Wire shield → negative (-) output terminal
-

Connection-shielding alt. If the wire shield needs to be grounded at the voltage source (EXT-V), then the shield cannot also be grounded at the negative (-) terminal output of the PHU power supply. This would short the output.

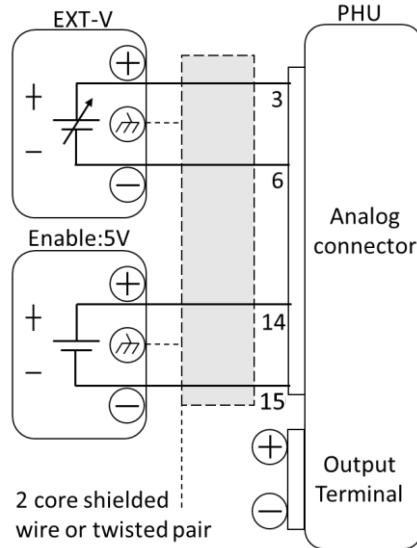

- Pin3 → EXT-V (+)
- Pin6 or Pin10 or Pin24 or Pin25 → EXT-V (-)
- Pin14 → Enable (+)
- Pin15 or Pin16 or Pin23 → Enable (-)
- Wire shield → EXT-V ground (GND)

- Panel operation
1. Connect the external voltage according to the connection diagrams above.
 2. Press the menu button and enter the “Configuration” icon.

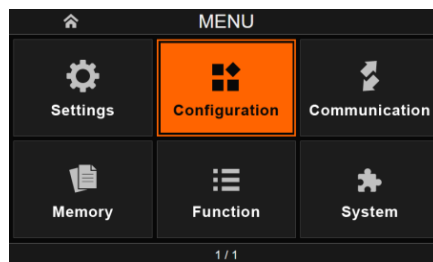

3. Choose the “Analog interface” in the Configuration page.

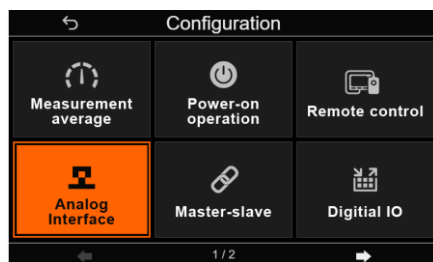

4. Check "Power control".



Note

Use a stable voltage supply for the external voltage control.



Ensure the voltage polarity is correct when connecting the external voltage.

Ensure no more than 10.5 volts or 5.25 volts are input into the external voltage input.

5-1-5. External Voltage Control of Internal Resistance

Background

External voltage control of the Internal Resistance is accomplished using the analog control connector on the rear panel. There are two external voltage control ranges, 0 V to 5 V and 0 V to 10V, depending on the configuration.

For 0 V to 10 V: Output Resistance = full scale Resistance x (external voltage/10)

For 0 V to 5 V: Output Resistance = full scale Resistance x (external voltage/5)

(Setting Path: Menu/Configuration/Analog interface/page2)

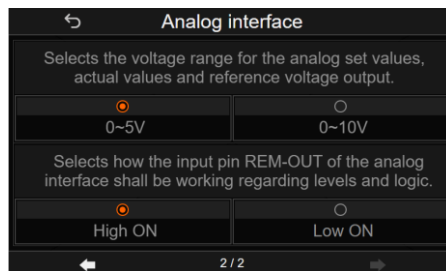

Connection

When connecting the external voltage source to the connectors, use shielded or twisted paired wiring.

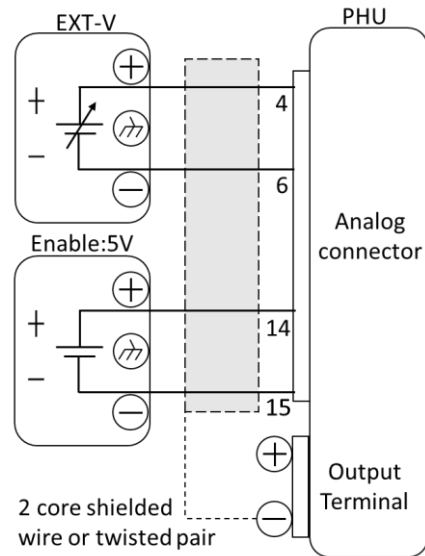

- Pin4 → EXT-V (+)
 - Pin6 or Pin10 or Pin24 or Pin25 → EXT-V (-)
 - Pin14 → Enable (+)
 - Pin15 or Pin16 or Pin23 → Enable (-)
 - Wire shield → negative (-) output terminal
-

Connection-shielding alt. If the wire shield needs to be grounded at the voltage source (EXT-V), then the shield cannot also be grounded at the negative (-) terminal output of the PHU power supply. This would short the output.

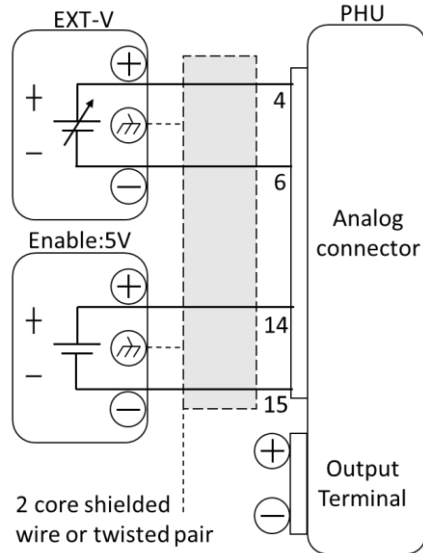

- Pin4 → EXT-V (+)
- Pin6 or Pin10 or Pin24 or Pin25 → EXT-V (-)
- Pin14 → Enable (+)
- Pin15 or Pin16 or Pin23 → Enable (-)
- Wire shield → EXT-V ground (GND)

Panel operation

1. Connect the external voltage according to the connection diagrams above.
2. Press the menu button and enter the “Configuration” icon.

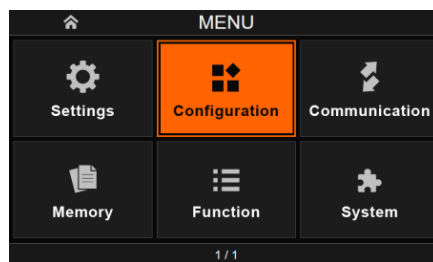

3. Choose the “Analog interface” in the Configuration page.

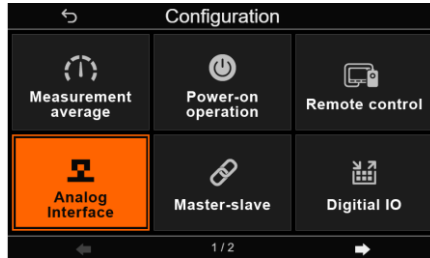

4. Check “Resistance control”.



Note

Use a stable voltage supply for the external voltage control.



Ensure the voltage polarity is correct when connecting the external voltage.

Ensure no more than 10.5 volts or 5.25 volts are input into the external voltage input.

5-1-6. External Resistance Control of Voltage Output

Background

External Resistance control of the voltage output is accomplished using the analog control connector on the rear panel. There are two external voltage control ranges, 0 V to 5 V and 0 V to 10V, depending on the configuration.

For 0 V to 10 V:

Output power = full scale power x (external voltage/10)

PIN 5 (VREF) will output 10V.

For 0 V to 5 V:

Output power = full scale power x (external voltage/5)

PIN 5 (VREF) will output 5V.

(Setting Path: Menu/Configuration/Analog interface/page2)

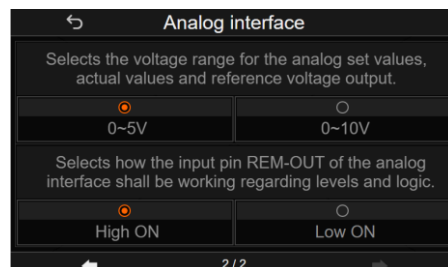

Connection

When connecting the external resistance to the connectors, use shielded or twisted paired wiring.

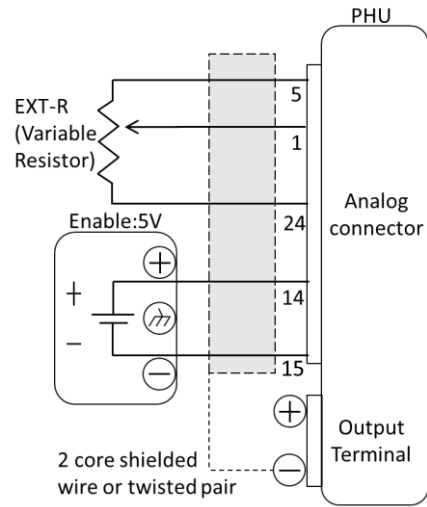

- Pin5 → VREF
 - Pin1 → EXT-V/R CV CONT
 - Pin6 or Pin10 or Pin24 or Pin25 → Analog GND
 - Pin14 → Enable (+)
 - Pin15 or Pin16 or Pin23 → Enable (-)
 - Wire shield → Negative (-) output terminal
 - Variable resistor: 10 kΩ to 1 MΩ
-

Connection-shielding alt. If the wire shield needs to be grounded at the enable voltage source, then the shield cannot also be grounded at the negative (-) terminal output of the PHU power supply. This would short the output.

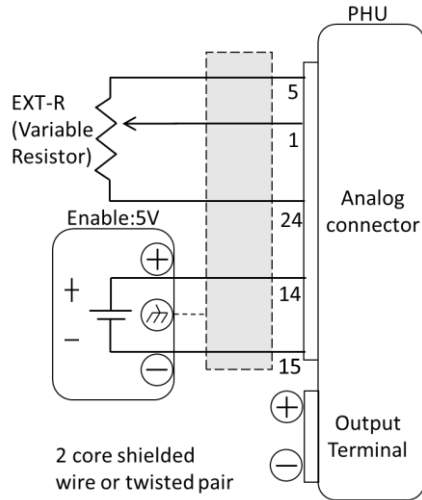

- Pin5 → VREF
- Pin1 → EXT-V/R CV CONT
- Pin6 or Pin10 or Pin24 or Pin25 → Analog GND
- Pin14 → Enable (+)
- Pin15 or Pin16 or Pin23 → Enable (-)
- Wire shield → Enable voltage ground (GND)
- Variable resistor: 10 kΩ to 1 MΩ

- Panel operation
1. Connect the external voltage according to the connection diagrams above.
 2. Press the menu button and enter the “Configuration” icon.

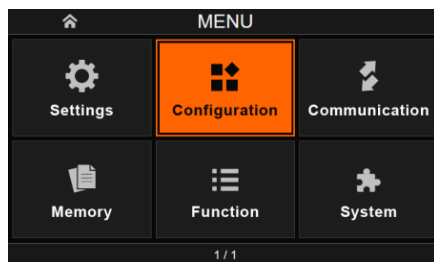

3. Choose the “Analog interface” in the Configuration page.

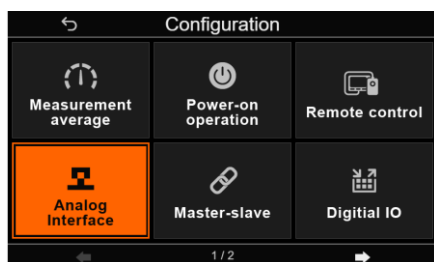

4. Check "Voltage control".



Note

Use a stable voltage supply for the external voltage control.



Ensure the voltage polarity is correct when connecting the external voltage.

Ensure no more than 5.25 volts are input into the external voltage input (enable: 5V).

5-1-7. External Resistance Control of Current Output

Background

External Resistance control of the current output is accomplished using the analog control connector on the rear panel. There are two external voltage control ranges, 0 V to 5 V and 0 V to 10 V, depending on the configuration.

For 0 V to 10 V:

Output power = full scale power x (external voltage/10)

PIN 5 (VREF) will output 10V.

For 0 V to 5 V:

Output power = full scale power x (external voltage/5)

PIN 5 (VREF) will output 5V.

(Setting Path: Menu/Configuration/Analog interface/page2)

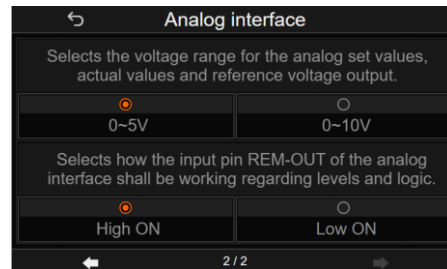

Connection

When connecting the external resistance to the connectors, use shielded or twisted paired wiring.

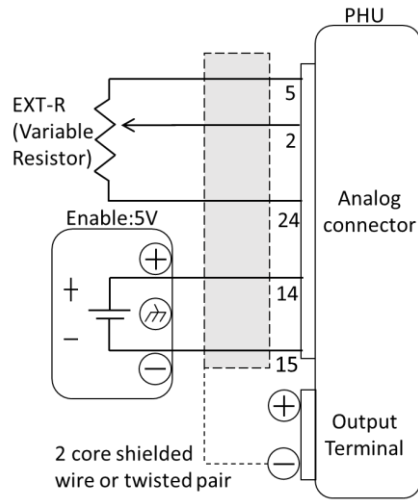

- Pin5 → VREF
 - Pin2 → EXT-V/R CC CONT
 - Pin6 or Pin10 or Pin24 or Pin25 → Analog GND
 - Pin14 → Enable (+)
 - Pin15 or Pin16 or Pin23 → Enable (-)
 - Wire shield → Negative (-) output terminal
 - Variable resistor: 10 kΩ to 1 MΩ
-

Connection-shielding alt. If the wire shield needs to be grounded at the enable voltage source, then the shield cannot also be grounded at the negative (-) terminal output of the PHU power supply. This would short the output.

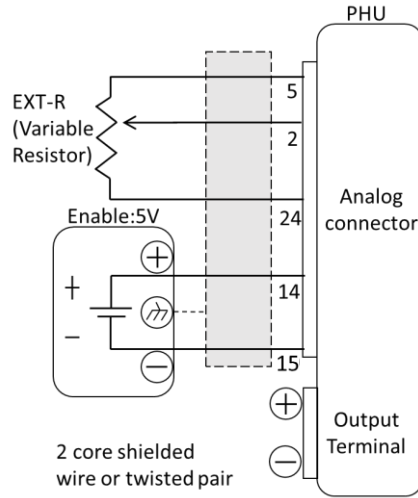

- Pin5 → VREF
- Pin2 → EXT-V/R CC CONT
- Pin6 or Pin10 or Pin24 or Pin25 → Analog GND
- Pin14 → Enable (+)
- Pin15 or Pin16 or Pin23 → Enable (-)
- Wire shield → Enable voltage ground (GND)
- Variable resistor: 10 kΩ to 1 MΩ

- Panel operation
1. Connect the external voltage according to the connection diagrams above.
 2. Press the menu button and enter the “Configuration” icon.

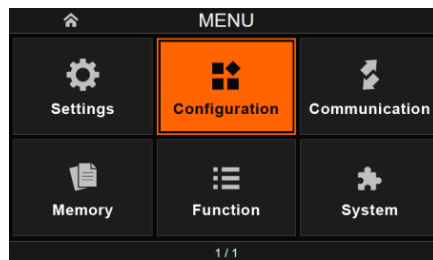

3. Choose the “Analog interface” in the Configuration page.

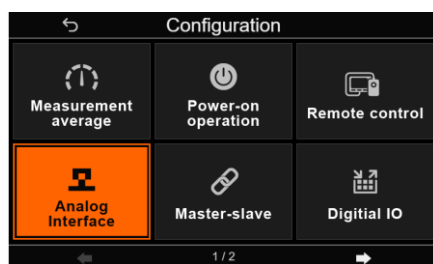

4. Check "Current control".



Note

Use a stable voltage supply for the external voltage control.



Ensure the voltage polarity is correct when connecting the external voltage.

Ensure no more than 5.25 volts are input into the external voltage input (enable: 5V).

5-1-8. External Resistance Control of Power Output

Background

External Resistance control of the power output is accomplished using the analog control connector on the rear panel. There are two external voltage control ranges, 0 V to 5 V and 0 V to 10 V, depending on the configuration.

For 0 V to 10 V:

Output power = full scale power x (external voltage/10)

PIN 5 (VREF) will output 10V.

For 0 V to 5 V:

Output power = full scale power x (external voltage/5)

PIN 5 (VREF) will output 5V.

(Setting Path: Menu/Configuration/Analog interface/page2)

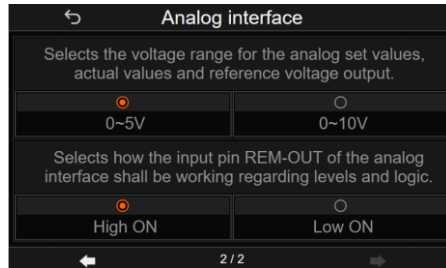

Connection

When connecting the external resistance to the connectors, use shielded or twisted paired wiring.

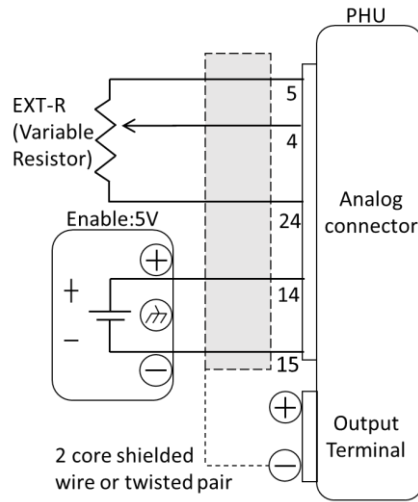

- Pin5 → VREF
 - Pin3 → EXT-V/R CP CONT
 - Pin6 or Pin10 or Pin24 or Pin25 → Analog GND
 - Pin14 → Enable (+)
 - Pin15 or Pin16 or Pin23 → Enable (-)
 - Wire shield → Negative (-) output terminal
 - Variable resistor: 10 kΩ to 1 MΩ
-

Connection-shielding alt. If the wire shield needs to be grounded at the enable voltage source, then the shield cannot also be grounded at the negative (-) terminal output of the PHU power supply. This would short the output.

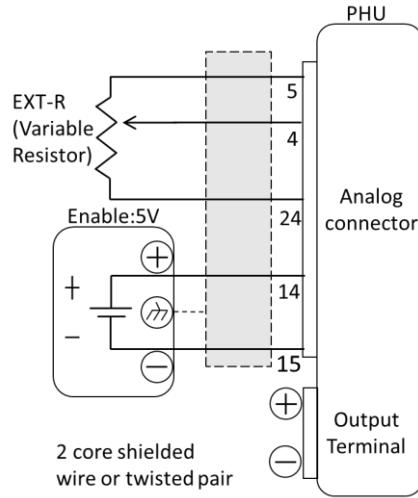

- Pin5 → VREF
- Pin3 → EXT-V/R CP CONT
- Pin6 or Pin10 or Pin24 or Pin25 → Analog GND
- Pin14 → Enable (+)
- Pin15 or Pin16 or Pin23 → Enable (-)
- Wire shield → Enable voltage ground (GND)
- Variable resistor: 10 kΩ to 1 MΩ

- Panel operation
1. Connect the external voltage according to the connection diagrams above.
 2. Press the menu button and enter the “Configuration” icon.

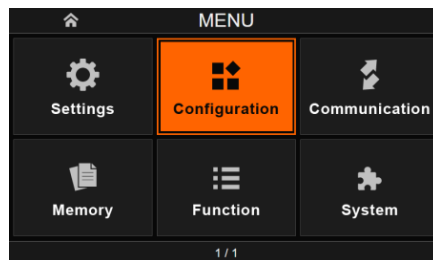

3. Choose the “Analog interface” in the Configuration page.

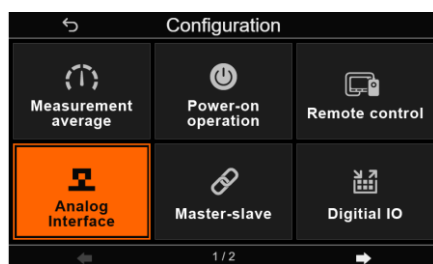

4. Check "Power control".



Note

Use a stable voltage supply for the external voltage control.



Ensure the voltage polarity is correct when connecting the external voltage.

Ensure no more than 5.25 volts are input into the external voltage input (enable: 5V).

5-1-9. External Resistance Control of Internal Resistance Output

Background

External Resistance control of the internal resistance is accomplished using the analog control connector on the rear panel. There are two external voltage control ranges, 0 V to 5 V and 0 V to 10 V, depending on the configuration.

For 0 V to 10 V:

Output power = full scale power x (external voltage/10)

PIN 5 (VREF) will output 10V.

For 0 V to 5 V:

Output power = full scale power x (external voltage/5)

PIN 5 (VREF) will output 5V.

(Setting Path: Menu/Configuration/Analog interface/page2)

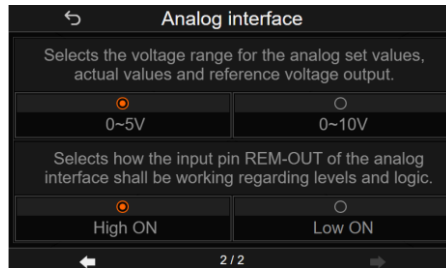

Connection

When connecting the external resistance to the connectors, use shielded or twisted paired wiring.

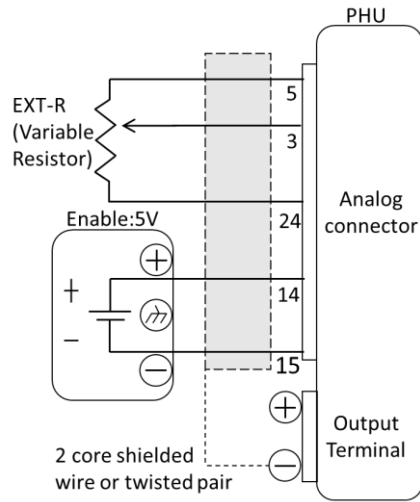

- Pin5 → VREF
 - Pin4 → EXT-V/R IN_R CONT
 - Pin6 or Pin10 or Pin24 or Pin25 → Analog GND
 - Pin14 → Enable (+)
 - Pin15 or Pin16 or Pin23 → Enable (-)
 - Wire shield → Negative (-) output terminal
 - Variable resistor: 10 kΩ to 1 MΩ
-

Connection-shielding alt. If the wire shield needs to be grounded at the enable voltage source, then the shield cannot also be grounded at the negative (-) terminal output of the PHU power supply. This would short the output.

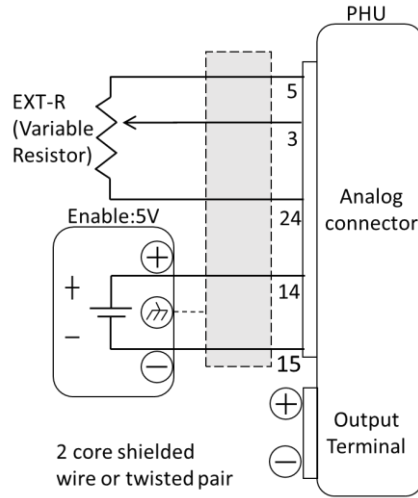

- Pin5 → VREF
- Pin4 → EXT-V/R IN_R CONT
- Pin6 or Pin10 or Pin24 or Pin25 → Analog GND
- Pin14 → Enable (+)
- Pin15 or Pin16 or Pin23 → Enable (-)
- Wire shield → Enable voltage ground (GND)
- Variable resistor: 10 kΩ to 1 MΩ

- Panel operation
1. Connect the external voltage according to the connection diagrams above.
 2. Press the menu button and enter the “Configuration” icon.

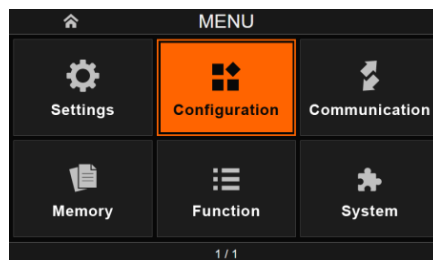

3. Choose the “Analog interface” in the Configuration page.

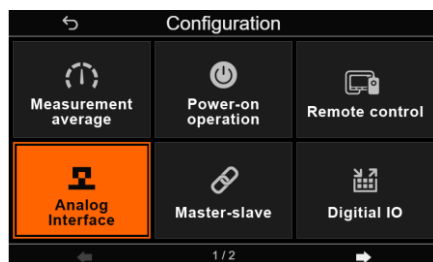

4. Check "Resistance control".



Note

Use a stable voltage supply for the external voltage control.



Ensure the voltage polarity is correct when connecting the external voltage.

Ensure no more than 5.25 volts are input into the external voltage input (enable: 5V).

5-1-10. External Voltage Control of Output

Background

The output can be turned on or off externally using input 0 V or 5 V. The analog control connector can be set to turn the output on from a high or low signal.

When set to High On, the output is turned on when input 5 V, the output is turned off when input 0 V.

When Low On, the output is turned on when input 0 V, the output is turned off when input 5 V.

(Setting Path: Menu/Configuration/Analog interface/page2)

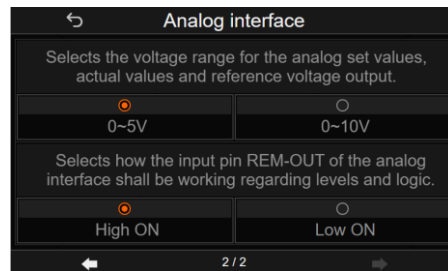

Connection

When connecting the external voltage source to the connectors, use shielded or twisted paired wiring.

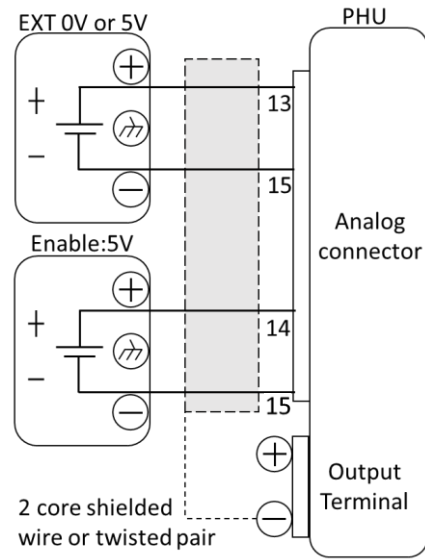

- Pin13 → EXT (+)
 - Pin15 or Pin16 or Pin23 → digital GND or Enable (-)
 - Pin14 → Enable (+)
 - Wire shield → Negative (-) output terminal
-

Connection- alt. shielding

If the wire shield needs to be grounded at the enable voltage source, then the shield cannot also be grounded at the negative (-) terminal output of the PHU power supply. This would short the output.

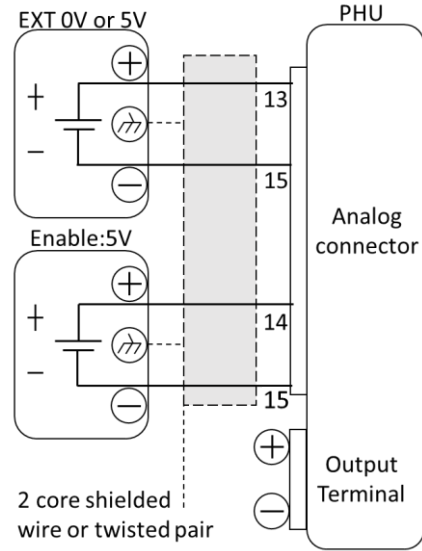

- Pin13 → EXT (+)
- Pin15 or Pin16 or Pin23 → digital GND or Enable (-)
- Pin14 → Enable (+)
- Wire shield → Enable voltage ground (GND)

Panel operation

1. Connect the external voltage according to the connection diagrams above.
2. Press the menu button and enter the “Configuration” icon.

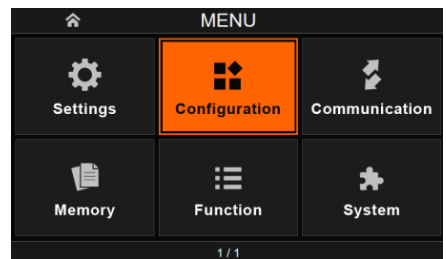

3. Choose the “Analog interface” in the Configuration page.

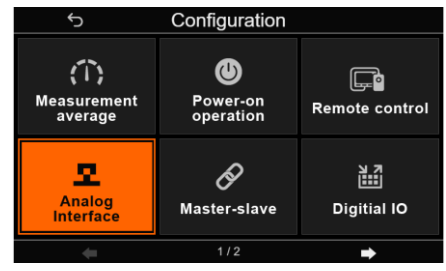

4. Check "REM-OUT control".



5. Choose High ON or Low ON on the second page.

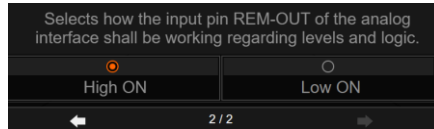

Note

Use a stable voltage supply for the external voltage control.



Ensure the voltage polarity is correct when connecting the external voltage.

Ensure no more than 5.25 volts are input into the external voltage input.

5-1-11. External voltage control of Alarm input

Background When a +4.5 V to +5 V high signal is input to PIN12 (Alarm input), it will forcibly turn off the PHU OUTPUT.

Connection When connecting the external voltage source to the connectors, use shielded or twisted paired wiring.

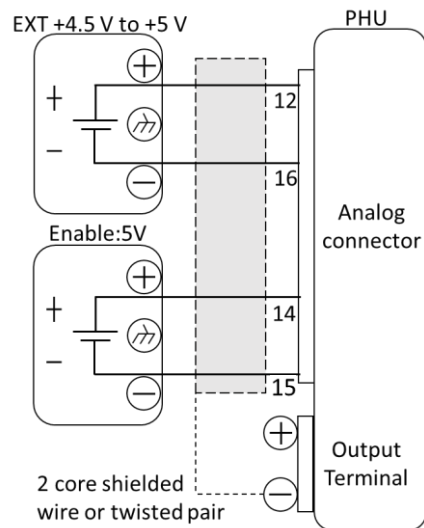

- Pin12 → EXT (+)
 - Pin15 or Pin16 or Pin23 → digital GND or Enable (-)
 - Pin14 → Enable (+)
 - Wire shield → Negative (-) output terminal
-

Connection- alt.
shielding

If the wire shield needs to be grounded at the enable voltage source, then the shield cannot also be grounded at the negative (-) terminal output of the PHU power supply. This would short the output.

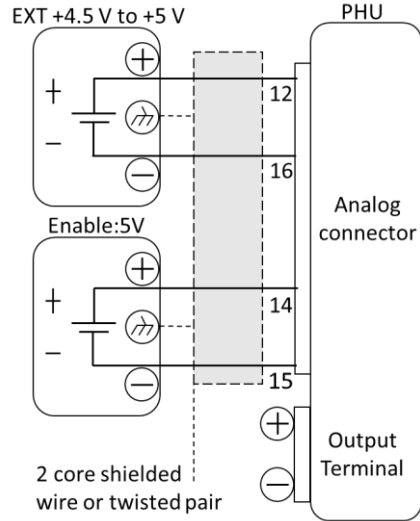

- Pin12 → EXT (+)
- Pin15 or Pin16 or Pin23 → digital GND or Enable (-)
- Pin14 → Enable(+)
- Wire shield → Enable voltage ground (GND)

Note

Use a stable voltage supply for the external voltage control.



Ensure the voltage polarity is correct when connecting the external voltage.

Ensure no more than 5.25 volts are input into the external voltage input.

5-2. Remote Monitoring

The PHU power supplies have remote monitoring support for current, voltage and power output. They also support monitoring of operation and alarm status.

5-2-1. External Voltage, Current and Power Monitoring

Background The analog connector is used to monitor the current (IMON), voltage (VMON) and power (PMON) output.

An output of 0 V to 10 V or 0 V to 5 V (depending on the configuration) represents the voltage or current output of 0 to rated current/voltage output.

- $IMON = (\text{current output/full scale}) \times 10 \text{ or } 5.$
- $VMON = (\text{voltage output/full scale}) \times 10 \text{ or } 5.$
- $PMON = (\text{power output/full scale}) \times 10 \text{ or } 5.$

Configuration The PHU doesn't need to be configured to use external voltage, current monitoring or power monitoring however the voltage or current output range does need to be configured. The monitor output voltage can be configured as either 0 V to 10 V or 0 V to 5 V.

(Setting Path: Menu/Configuration/Analog interface/page2)

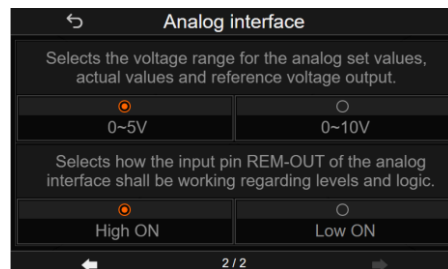

An external DMM can now be used to monitor the voltage or current output.

VMON Connection

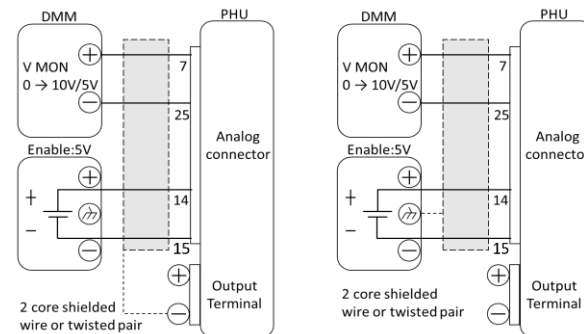

- Pin7 → DMM (+)
- Pin6 or Pin10 or Pin24 or Pin25 → DMM (-)
- Pin14 → Enable(+)
- Pin15 or Pin16 or Pin23 →Enable (-)

IMON Connection

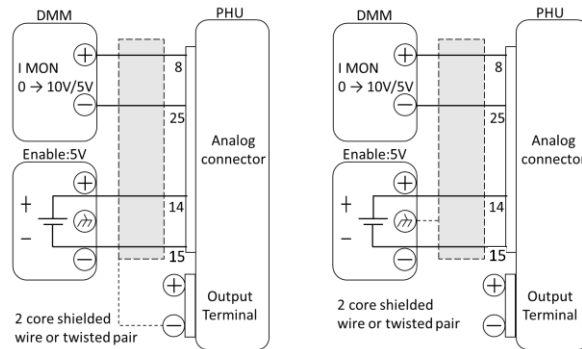

- Pin8 → DMM (+)
- Pin6 or Pin10 or Pin24 or Pin25 → DMM (-)
- Pin14 → Enable(+)
- Pin15 or Pin16 or Pin23 →Enable (-)

PMON Connection

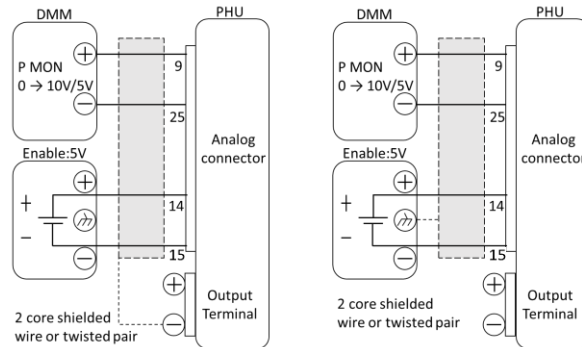

- Pin9 → DMM (+)
- Pin6 or Pin10 or Pin24 or Pin25 → DMM (-)
- Pin14 → Enable(+)
- Pin15 or Pin16 or Pin23 →Enable (-)

Note

Maximum current is 5 mA. Ensure the sensing circuit has input impedance greater than 1MΩ.

The monitor outputs are strictly DC and should not be used to monitor analog components such as transient voltage response or ripple etc.



Ensure IMON (pin 7), VMON (pin 8) and PMON (pin 9) are not shorted together. This may cause damage to the unit.

5-2-2. External Operation and Status Monitoring

Background The analog control connector can also be used to monitor the status operation and alarm status of the instrument.

The pins are isolated from the power supply internal circuitry by photo couplers. Status Com (Pin 15), Status Com (Pin 16) and Status Com (Pin 23) are photo coupler emitter outputs, whilst pins 17 to 22 are photo coupler collector outputs.

A maximum of 30V and 8mA can be applied to each pin. The Status Com pin is floating with an isolation voltage of 60V.

Pinout	Name and Pin	Description
	STATUS COM1 15 16 23	Common (photo coupler emitter) for status signals 17 to 22.
	OUT ON STATUS 17	Low when the output is on.
	PWR ON STATUS 18	Active low.
	ALM STATUS 19	Low when any of the protection modes are tripped. Active low.
	CV STATUS 20	Low when CV mode is active.
	CC STATUS 21	Low when CC mode is active.
	CP STATUS 22	Low when CP mode is active.

Schematic

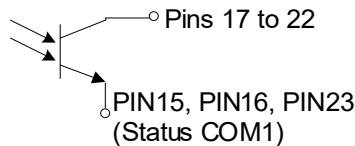

Timing diagrams Below are 6 example timing diagrams covering a number of scenarios. Note that pins 17 to 19 are all active low.

CV MODE: Output turned on The diagram below shows the timing diagram when the output is turned on when the PHU is in the CV mode. (The PHU output mode is set to CVHS mode.)

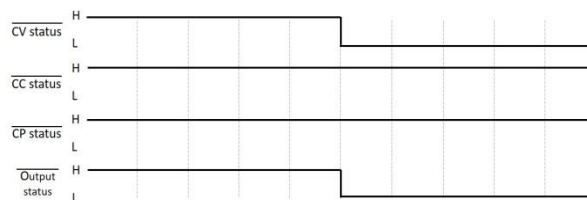

CV MODE: Output turned off The diagram below shows the output status lines when the output is turned off in CV mode.

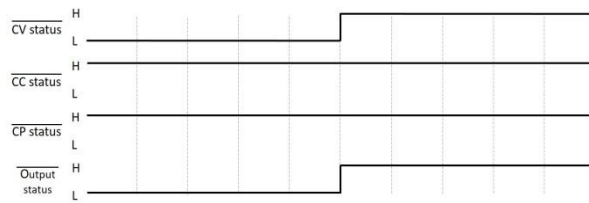

CC MODE: The diagram below shows the timing diagram when the output is turned on when the PHU is in the CC mode. (The PHU output mode is set to CCHS mode.)
Output turned on

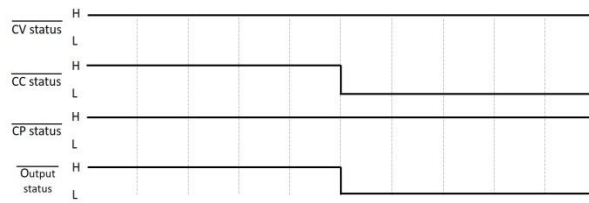

CC MODE: The diagram below shows the output status lines when the output is turned off in CC mode.
Output turned off

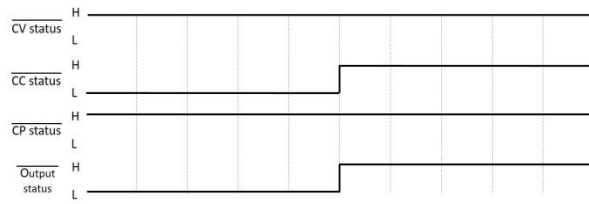

CP MODE: The diagram below shows the timing diagram when the output is turned on when the PHU is in the CP mode. (The PHU output mode is set to CVHS mode.)
Output turned on

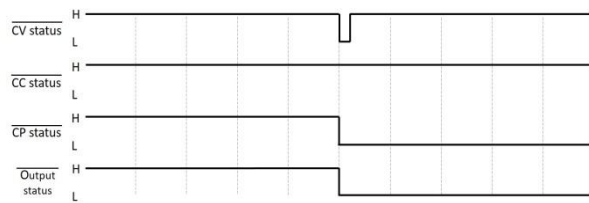

CP MODE: The diagram below shows the output status lines when the output is turned off in CP mode.
Output turned off

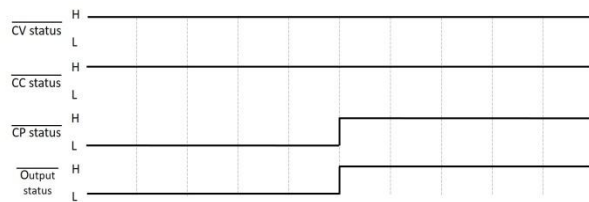

6. COMMUNICATION INTERFACE

This chapter describes basic configuration of IEEE488.2 based remote control. For a command list, refer to the programming manual, downloadable from TEXIO TECHNOLOGY website,

<https://www.texio.co.jp>

6-1. USB Remote Interface

6-1-1. USB Configuration

USB Configuration	PC side connector	Type A, host
	PHU side connector	Rear panel Type B, slave
	Speed	1.1/2.0 (full speed/high speed)
	USB Class	CDC(communications device class) TMC(test and measurement class)

Steps 1. Connect the USB cable to the rear panel USB B port.

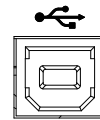

Note If you are not using the rear panel USB device port, set Rear USB Disable.

Page 80

2. The interface state indication area of display will show the status.

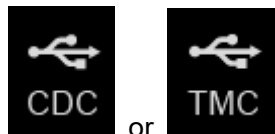

6-1-2. USB Function Check

Functionality check	<p>Invoke a terminal application such as Realterm.</p> <p>To check the COM port No., see the Device Manager in the PC. For WinXP; Control panel → System → Hardware tab.</p> <p>Run this query command via the terminal application after the instrument has been configured for USB remote control.</p> <p>*idn?</p> <p>This should return the Manufacturer, Model number, Serial number, and Firmware version in the following format.</p> <p>TEXIO TECHNOLOGY, PHU-153M500,GW0470500400,01.26.20241001.001</p> <p>Manufacturer : TEXIO TECHNOLOGY</p> <p>Model number : PHU-153M500</p> <p>Serial number : GW0470500400</p> <p>Firmware version : 01.26.20241001.001</p>
Note	<p>For further details, please see the programming manual, available on the TEXIO TECHNOLOGY web site.</p> <p>https://www.texio.co.jp</p>

6-2. GPIB Remote Interface (optional)

To use GPIB, the optional GPIB option (GW Instek part number: PHU-IF01) must be installed. This is a factory installed option and cannot be installed by the end-user. Only one GPIB address can be used at a time.

6-2-1. GP-IB Configuration

- Configure GPIB
1. Ensure the PHU is off before proceeding.
 2. Connect a GPIB cable from a GPIB controller to the GPIB port on the PHU.
 3. Turn the PHU on.
 4. Press the menu key and enter the communication page, choose the “GPIB”.

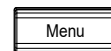
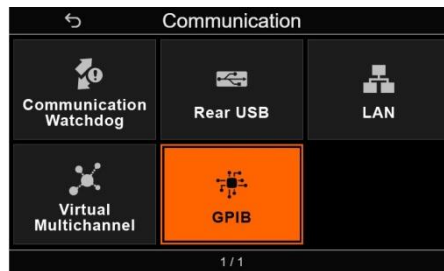

5. Set the following GPIB settings.

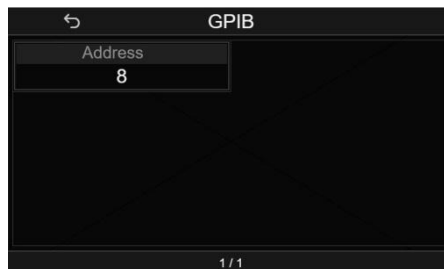

GPIB Address 1 to 30

6. Check to see that the GPIB option is detected by the PHU. The block of the slot interface indicates the GPIB port status.

Indicates that the GPIB port is available.



- GPIB constraints
- Maximum 15 devices altogether, 20m cable length, 2m between each device
 - Unique address assigned to each device
 - At least 2/3 of the devices turned On
 - No loop or parallel connection

6-2-2. GP-IB Function Check

Background	To test the GPIB functionality, National Instruments Measurement and Automation Explorer can be used. Users need to install NI488.2. This program is available on the NI website, https://www.ni.com
Note	For further details, please see the programming manual, available on the TEXIO TECHNOLOGY web site https://www.texio.co.jp

- Functionality check
1. Start the NI Measurement and Automation Explorer (MAX) program. Using Windows, press:
Start>All Programs>NI Max

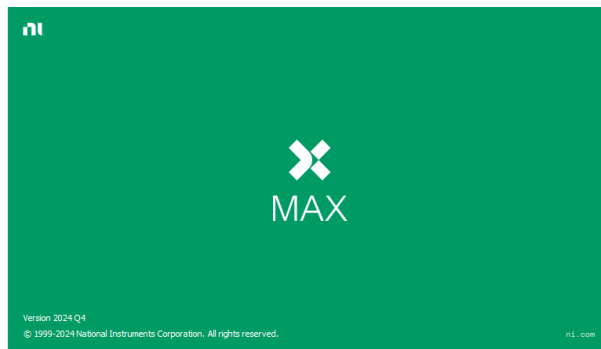

2. From the Configuration panel access;
My System>Devices and Interfaces>GPIB
3. Press Scan for Instruments.

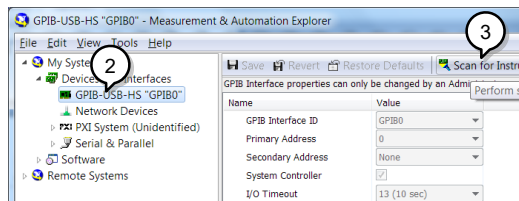

4. Select the device (GPIB address of PHU) that now appears in the System>Devices and Interfaces > GPIB-USB-HS "GPIBX" node.
5. Click on the VISA Properties tab on the bottom.
6. Click Open Visa Test Panel.

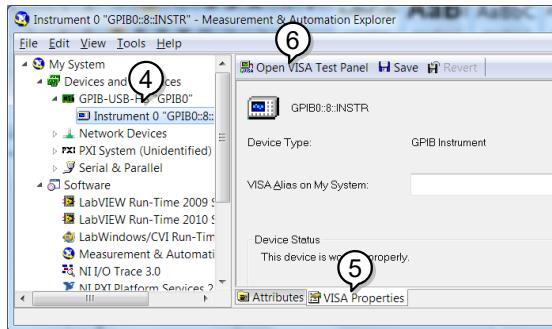

7. Click on Configuration.
8. Click on the GPIB Settings tab and confirm that the GPIB settings are correct.

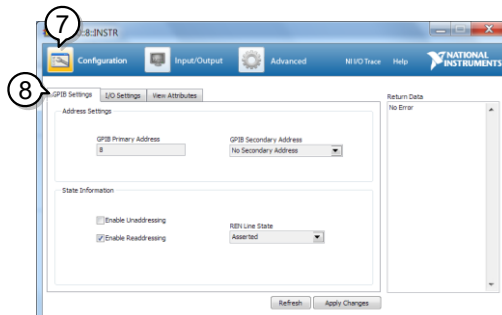

9. Click on the I/O Settings tab.
10. Make sure the Enable Termination Character check box is checked, and the terminal character is $\r\n$ (Value: $\r\n$).
11. Click Apply Changes.

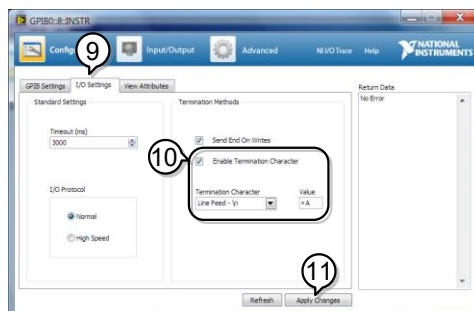

12. Click on Input/Output.
13. Click on the Basic/IO tab.
14. Enter *IDN? in the Select or Enter Command drop down box.
15. Click Query.
16. The *IDN? query will return the Manufacturer, model name, serial number and firmware version in the dialog box.

TEXIO TECHNOLOGY,PHU-
153M500,GW0470500400,01.26.20241001.001\r\n

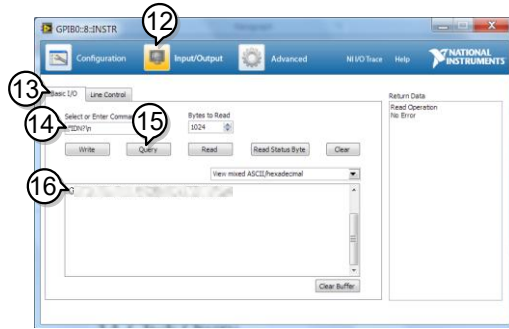

6-3. RS232/485 Remote Interface (optional)

The PHU uses the RS232/485 interface card (IN & OUT ports) for communication coupled with RS232 or RS485 adapters.

6-3-1. Configure RS232/485

The pin outs for the adapters are shown below.

PHU-232
RS232 cable
with DB9
connector

DB-9 Connector			Remote IN Port (RJ-45)	Remark
Pin No.	Name		Pin No.	
Housing	Shield	↔	Housing	
2	RX		7	Twisted pair
3	TX		8	
5	SG		1	

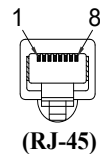
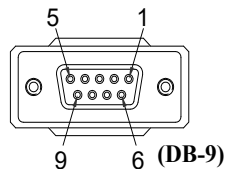

PHU-485
RS485 cable
with DB9
connector

DB-9 Connector			Remote IN Port (RJ-45)		Remark
Pin No.	Name		Pin No.	Name	
Housing	Shield	↔	Housing	Shield	
9	TXD-	↔	6	RXD-	Twisted pair
8	TXD+	↔	3	RXD+	
1	SG	↔	1	SG	
5	RXD-	↔	5	TXD-	Twisted pair
4	TXD+	↔	4	TXD+	

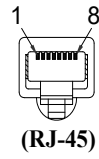
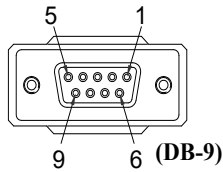

To use RS485-2W, please refer to this wiring

DB-9 Connector			Remote IN Port(RJ-45)		Remark
Pin No.	Name		Pin No.	Name	
Housing	Shield	↔	Housing	Shield	
9	TXD-	↔	6	RXD-	Twisted pair
8	TXD+	↔	3	RXD+	
1	SG	↔	1	SG	
5	RXD-	↔	5	TXD-	Twisted pair
4	RXD+	↔	4	TXD+	

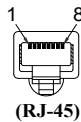
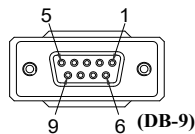
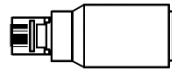

Diagram of End terminal connector



End terminal connector from PHU-232 or PHU-485 connection kit.	Intermediate connector					
	8 Pin (Male)			8 Pin (Female)		
Pin No.	Name		Pin No.	Name	Remarks	
Housing	Shield	↔	Case	Shield		
1	SG	↔	1	SG		
6	TXD -	↔	6	TXD -	Internal paralleled by 120 ohm	
3	TXD +	↔	3	TXD +		
5	RXD -	↔	5	RXD -	Internal paralleled by 120 ohm	
4	RXD+	↔	4	RXD +		

Steps

1. Connect the RS232 serial cable (include in the PHU-232 connection kit) or RS485 serial cable (include in the PHU-485 connection kit) to the Remote IN port on the real panel.

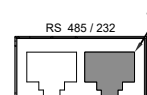

Connect the other end of the cable to the PC.

2. Connect the intermediate connector (include in the PHU-232 or PHU-485 connection kit) to the Remote OUT port on the rear panel.

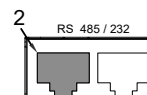

Note If the user is using a PC to send commands via RS485 (as shown in the figure), it is recommended to connect a 120Ω resistor in parallel at the PC's output terminals — between RXD- & RXD+, and between TXD- & TXD+.

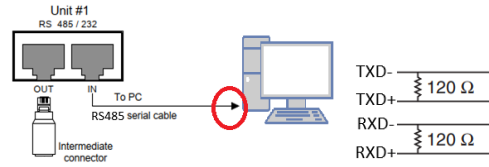

3. Press the menu key to enter the communication page, choose the RS232/485.

Set the following RS232/RS485 settings:

Mode	DISABLE/RS232/RS485
Address	0 to 31
baud rate settings	2400/ 4800/ 9600/ 19200/ 38400/ 57600/ 115200
Protocol	SCPI

4. The Block of interface state will display this icon when a remote connection has been established.



6-3-2. RS-232C/485 Function Check

Functionality check

Invoke a terminal application such as Realterm.

To check the COM port No, see the Device Manager in the PC. For Win 11; Control panel → System → Hardware tab.

Run this query command via the terminal application after the instrument has been configured for either RS232 or RS485 remote control.

Run this query command via the terminal application after the instrument has been configured for RS232 or RS485 remote control.

*idn?

This should return the Manufacturer, Model number, Serial number, and Firmware version in the following format.

TEXIO TECHNOLOGY, PHU-
153M500,GW0470500400,01.26.20241001.001

Manufacturer : TEXIO TECHNOLOGY

Model number : PHU-153M500

Serial number : GW0470500400

Firmware version : 01.26.20241001.001

Note For further details, please see the programming manual, available on the TEXIO TECHNOLOGY web site.

6-3-3. RS232/RS485 Multiple Unit Connection (Legacy mode)

The PHU power supplies can have up to 31 units daisy chained together using the 8 pin connectors (IN OUT ports) on the rear panel. The first unit (master) in the chain is remotely connected to a PC using RS232 or RS485. Each subsequent unit (slave) is daisy chained to the next using a RS485 local bus. The OUT port of the first unit must be connected to intermediate connector and the OUT port of the last unit must be connected to another intermediate connector.

The PC is allowed to use RS232 or RS485 to connect to the first device. The remote command supports the SCPI commands.

Each unit is assigned a unique address, which can then be controlled independently of the host PC.

Slave serial link cable with RJ-45 shielded connectors from PHU-232 or PHU-485 connection kit	RS-485 slave serial link pin assignment						
	8 Pin Connector (IN)(RJ-45)				8 Pin Connector (OUT)(RJ-45)		
	Pin No.	Name		Pin No.	Name		
	Housing	Shield	↔	Housing	Shield		
	1	SG	↔	1	SG		
	6	TXD -	↔	6	TXD -		
	3	TXD +	↔	3	TXD +		
	5	RXD -	↔	5	RXD -		
	4	RXD +	↔	4	RXD +		

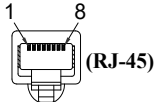
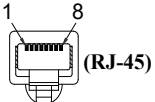
- Operation
1. Check the SW version (Menu→ System → About) first on all units. The SW version must be the same on all units before any multiple unit connection can be established.

Example

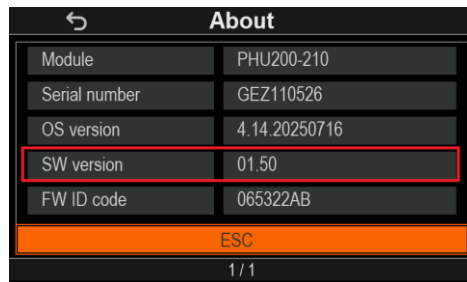

2. Connect the first unit's IN port to a PC via RS232 or RS485 serial cable.
Use the serial cables supplied in the PHU-232 or PHU-485 connection kit.

3. RS232 mode: Plug in intermediate connector to the OUT port on the first unit.
RS485 mode: Two 120 Ω terminal resistor should be added to the PC output.

Then using the slave serial link cable (black plug) to connect intermediate connector to the IN port of the second unit.

Connect all the remaining units in the same fashion until all the units have been daisy-chained together.

Terminate the OUT port of the last unit with the intermediate connector included in the PHU-232 or PHU-485 connection kit.

RS232

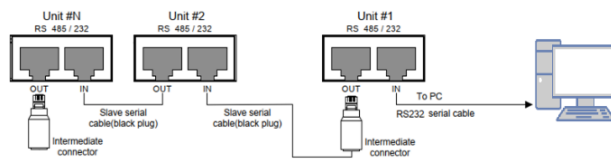

RS485

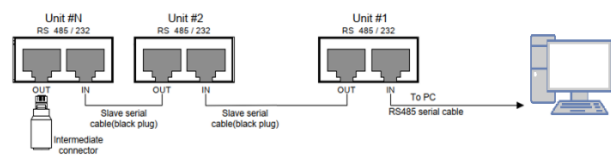

Note

If the user is using a PC to send commands via RS485, it is recommended to connect a 120Ω resistor in parallel at the PC's output terminals - between RXD- & RXD+, and between TXD- & TXD+.

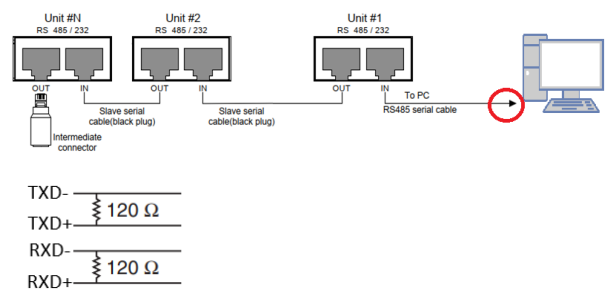

4. Press the Menu -> Communication-> RS232/RS485 settings for the all unit.

Set the following settings:

Mode:

DISABLE/RS2 32/ Configure the unit as you normally would for RS232 or RS485 remote control (set all units the same).

RS485

Baud rate(bps):

2400/4800/9600
0/19200/38400
/57600/115200

Address: Set the address of each unit. It must be a unique address
0~128 identifier.

Protocol: SCPI The remote command supports the SCPI commands.

5. Multiple units can now be operated at the same time. See the programming manual or see the function check below for usage details.

6-3-4. RS232/485 Multiple units Function Check

Functionality check Invoke a terminal application such as Realterm.

To check the COM port No, see the Device Manager in the PC. For Win11; Control panel → System → Hardware tab.

When using SCPI commands, each unit can be individually controlled using the unique address identifiers. For this function check, we will assume that the master unit is assigned to address 8, while a slave is assigned address 11. Run this query command via the terminal application after the instruments have been configured for multi-unit control with Legacy mode.

SCPI commands	Command or response	Status
	:ADR 8	Typing
	*IDN?	Typing
	TEXIO,PHU-153L200	Return
	Selects the PHU with address 8 and returns its identity string.	Note
	:ADR 11	Typing
	*IDN?	Typing
	TEXIO, PHU-153M750	Return
	Selects the PHU with address 11 and returns its identity string.	Note

6-4. Configure Ethernet Connection

The Ethernet interface can be configured for a number of different applications. Ethernet can be configured for basic remote control or monitoring using a web server or it can be configured as a socket server.

The PHU series supports both DHCP connections so the instrument can be automatically connected to an existing network or alternatively, network settings can be manually configured.

Ethernet configuration Parameters For details on how to configure the Ethernet settings, please see the configuration chapter on page 81.

6-4-1. Web Server Configuration

Configuration This configuration example will configure the PHU as a web server and use DHCP to automatically assign an IP address to the PHU.

1. Connect an Ethernet cable from the network to the rear panel Ethernet port.
2. Press the Menu key to enter the LAN settings in the communication page.

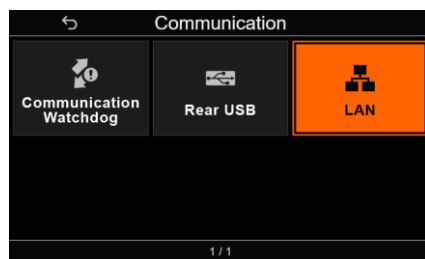
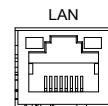

Set the following LAN settings:

Set IP allocation Manual or DHCP

IP Address

Gateway

Subnet mask

Port

Web control Enable or disable

Host name

Web password

Domain name

TCP Keep-alive Enable or disable

- The block of ethernet will display an icon when a network cable is plugged in



6-4-2. WEB Server Remote Control Function Check

Functionality check

Enter the IP address of the power supply in a web browser after the instrument has been configured as a web server.

The web server allows you to monitor the function settings of the PHU.

You can check the IP address by checking the LAN setting.

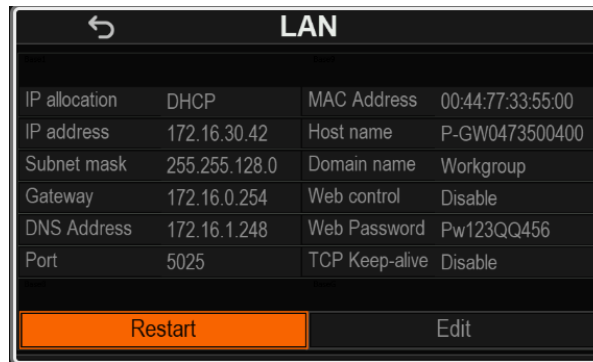

(The image is for example.)

[http:// AAA.BBB.CCC.DDD](http://AAA.BBB.CCC.DDD)

The web browser interface appears.

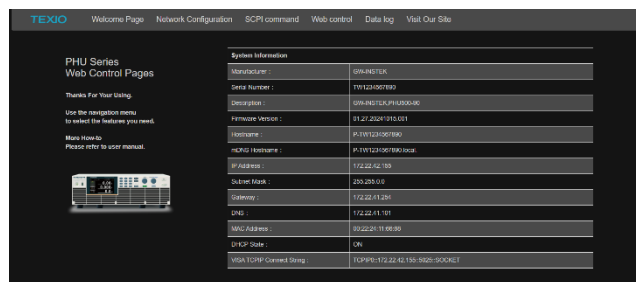

The web browser interface allows you to access the following:

- welcome page
- Network configuration
- SCPI command
- Web control
- Data log
- Visit our site

Note

For further details, please see the programming manual, available on the TEXIO TECHNOLOGY web site.

6-4-3. Sockets Server Configuration

Configuration This configuration example will configure the PHU socket server.
The following configuration settings will manually assign the PHU an IP address and enable the socket server. The socket server port number is fixed at 5025.

1. Connect an Ethernet cable from the network to the rear panel Ethernet port.



2. Press the Menu key to enter the LAN settings.

Set the following LAN settings:

Set IP allocation Manual or DHCP

Set IP Address

Set Gateway

Set Subnet mask

Set Port

Set Web control Enable or disable

Set Host name

Set Web password

Set Domain name

Set TCP Keep-alive Enable or disable

6-4-4. Socket Server Function Check

Background To test the socket server functionality, National Instruments Measurement and Automation Explorer can be used. This program is available on the NI website, www.ni.com, via a search for the VISA Run-time Engine page, or “downloads” at the following URL, <http://www.ni.com/visa/>

Requirements Operating System: Windows 7, 8, 10, 11

- Functionality check**
1. Start the NI Measurement and Automation Explorer (MAX) program. Using Windows, press:
Start>All Programs>NI Max

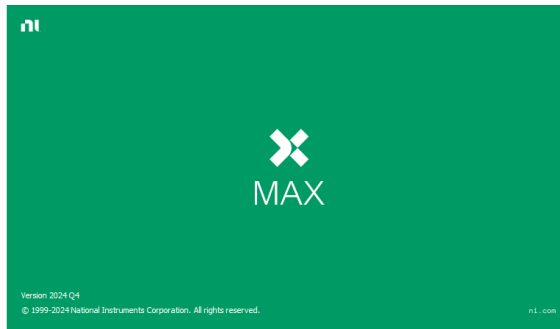

2. From the Configuration panel access;
My System>Devices and Interfaces>Network Devices
3. Press Add New Network Device>VISA TCP/IP Resource...

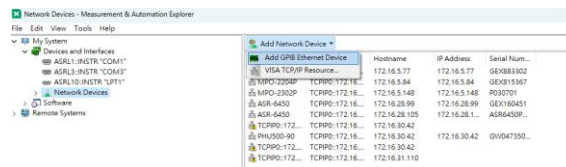

4. Select Manual Entry of Raw Socket from the popup window.

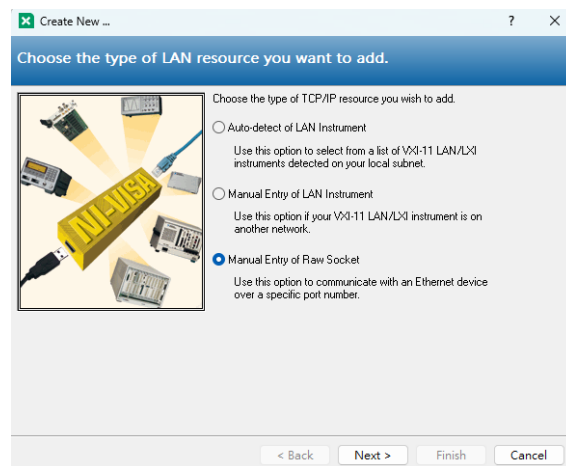

5. Enter the IP address and the port number of the PHU. The default port number is 5025.
6. Click the Validate button.
7. A popup will appear if a connection is successfully established.
8. Click Next.



9. Next configure the Alias (name) of the PHU connection. In this example the Alias is:

PHU-153M500

10. Click finish.

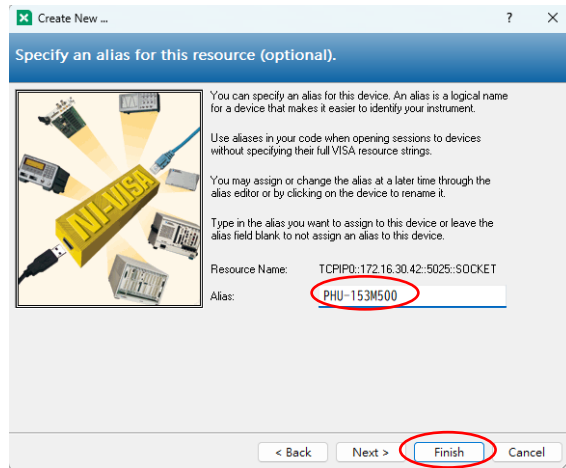

11. The IP address of the PHU will now appear under Network Devices in the configuration panel. Select this icon now.

12. Click Open VISA Test Panel.

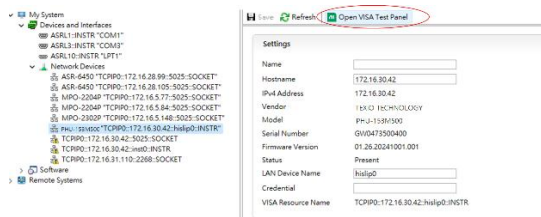

13. Click the Configuration icon.

14. Click on I/O Settings.

15. Make sure the Enable Termination Character check box is checked, and the terminal character is \n (Value: xA).

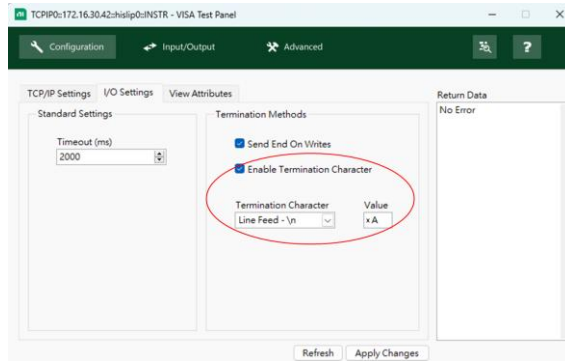

16. Click Apply Changes.
17. Click the Input/Output icon.
18. Enter *IDN? in the Select or Enter Command dialog box if it is not already.
19. Click the Query button.
20. The *IDN? query will return the Manufacturer, model name, serial number and firmware version in the dialog box.

例

TEXIO TECHNOLOGY, PHU-153M500,GW0470500400,01.26.20241001.001

Manufacturer : TEXIO TECHNOLOGY

model name : PHU-153M500

serial number : GW0470500400

firmware version : 01.26.20241001.001

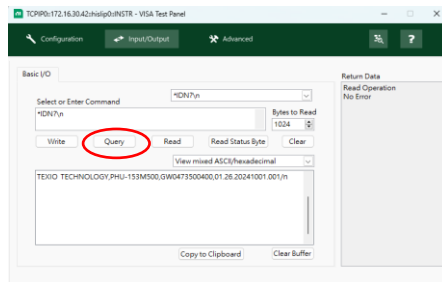

Note

For further details, please see the programming manual, available on the TEXIO TECHNOLOGY web site.

<https://www.texio.co.jp>

7. FAQ

- Q The OVP voltage is triggered earlier than expected.
- A When setting the OVP voltage, take into account the voltage drop from the load cables. As the OVP level is set from the output terminals and not the load terminals, the voltage at the load terminals may be slightly lower.
-
- Q Can I combine more than 1 cable together for the output wiring?
- A Yes. Cables can be used together (in parallel) if the current capacity of a single cable is insufficient. However the withstand voltage should also be taken into account. Ensure the cables are twisted together and are the same length.
-
- Q The accuracy does not match the specification.
- A Make sure the device is powered On for at least 30 minutes, within +20°C~+30°C. This is necessary to stabilize the unit to match the specification.

For more information, contact your local dealer or TEXIO TECHNOLOGY.

8. APPENDIX

8-1. PHU Factory Default Settings

The following default settings are the factory configuration settings for the power supply. For details on how to return to the factory default settings, see page 33.

Initial Settings	Default Setting
Output	Off
LOCK	Disabled
Voltage	0V
Current	0A
Internal resistance setting	0.000Ω
OVP	1.1 X Vrate
OCP	1.1 X Irate
OPP	1.1 X Prate
OCP Delay Time	0.1 sec
Current Setting Limit	1.05 X Irate
Voltage Setting Limit	1.05 X Vrate
Power Setting Limit	1.02 X Prate
Bleeder circuit control	ON
Output ON delay time	0.00 s
Output OFF delay time	0.00 s
output mode slew rate select	CV high speed priority (CVHS)
Rising/Falling voltage	Max(refer to page 46)
Rising/Falling current	Max(refer to page 46)
Under voltage detection	1.05 X Vrate action: NONE
Over voltage detection	1.05 X Vrate action: NONE
Under current detection	1.05 X Irate action: NONE
Over current detection	1.05 X Irate action: NONE
Over Power detection	1.02 X Prate action: NONE
Normal Function Settings	Default Setting
Measurement Average Setting	Low
The panel is displayed at power-on.	Display the Voltage Current
The output state after power-on.	Output is OFF

Actions after power-on.	None
Remote control	Not allowed
Analog interface	None selected.
The voltage range for the analog	0 V ~ 5 V
PIN REM-OUT of the analog interface	High ON
Master-slave setting	Single
DIO Function	None

Communication	Default Setting
----------------------	------------------------

Communication Watchdog	60(s)
Rear usb device mode	USB-CDC
LAN allocation	DHCP
LAN Port	5025
Web control	Enable
Host name	P-GW0473500400
Web password	Pw123QQ456
Domain name	Workgroup
TCP Keep-alive	Enable

Function	Default Setting
-----------------	------------------------













Sequence	no data
----------	---------



System	Default Setting
---------------	------------------------





AC-FAIL protection	Auto
AC Power Recovery setting	Power off
Lock Mode	Allow output to turn off
Key sound	Activates
Alarm sound	Activates
Backlight off after 60s	Deactivates
Brightness adjust	50 %







8-2. Messages



The following messages may appear on the PHU screen during operation. (Corresponding to page 7)













Remote State Messages	Description
	local
	local + Error
	Remote The device is in Remote status. Only the [Local] and [Output OFF] buttons are available.
	Remote Error The device is in Remote status. A command error has occurred.
	RWLock The device is in Remote + Lock status. All buttons are inactive.
	RWLock + Error The device is in Remote + Lock status. A command error has occurred.
	Local + Remote The device is in Local + Remote status. All buttons are functional, with remote control active simultaneously.
	Local + Remote The device is in Local + Remote status. A command error has occurred.
Protection State Messages*	Description
	None
	PF (Power Fail)
	OVP (Over-Voltage Protection)
	OCP (Over-Current Protection)

OPP	OPP (Over-Power Protection)
 OTP	OTP (Over-Temperature Protection)
SLF	SLF (Sense Lead Fault)
MSP	MSP (Master-Slave Protection)
PUF	PUF (Power Unit Fail)
WDOG	WDOG (communication Watchdog)
EXT Alarm	EXT Alarm (Shutdown for Analog Interface)
 Alarm	System error or Hardware error.
LLF	LLF (Load Lead Fault)
PUF1	PUF1 (Power Unit 1 Fault)
PUF2	PUF2 (Power Unit 2 Fault)
PUF3	PUF3 (Power Unit 3 Fault)
PUF4	PUF4 (Power Unit 4 Fault)
PUF5	PUF5 (Power Unit 5 Fault)
PUF6	PUF6 (Power Unit 6 Fault)
FAN1	FAN1 (FAN 1 Fault)
FAN2	FAN2 (FAN 2 Fault)
FAN3	FAN3 (FAN 3 Fault)

	UVA (Under Voltage Alarm) (When the UVD action is set to "ALARM")
	OVA (Over Voltage Alarm) (When the OVD action is set to "ALARM")
	UCA (Under Current Alarm) (When the UCD action is set to "ALARM")
	OCA (Over Current Alarm) (When the OCD action is set to "ALARM")
	OPA (Over Power Alarm) (When the OPD action is set to "ALARM")

Front USB State Messages	Description
	None
	USB Storage ON
	USB Storage Access
	USB Storage Error
	USB Storage Log active
	USB Storage Log access
	USB Storage Log abnormal

Rear USB State Messages	Description
	None
	USB-CDC
	USB-TMC















Ethernet State Messages	Description
	LAN OFF
	LAN ON
	LAN Connect-1
	LAN Connect-2
Option interface state Messages	Description
	None
	GP-IB
	RS485
Function state Messages	Description
	None
	Sequence
	Battery simulation
	Battery charge
	DIN 40839
	Solar Array Simulator EN50530

Output Mode Messages	Description
CVHS	Output Mode: CV high speed priority
CCHS	Output Mode: CC high speed priority
CVLS	Output Mode: CV slew rate priority
CCLS	Output Mode: CC slew rate priority

Output Delay state Messages	Description
	None
Dly On Dly Off	Both Output ON delay time and Output OFF delay time are set to non-zero values.
Dly On	Output ON delay time is set to non-zero values. Output OFF delay time is set to zero.
Dly Off	Output ON delay time is set to zero. Output OFF delay time is set to non-zero values.



Bleeder control state Messages	Description
Bleeder ON	Turns ON the bleeder resistor.
Bleeder OFF	Turns OFF the bleeder resistor.
Bleeder Auto	When set to AUTO, the bleeder resistor operates in synchronization with the output, automatically turning on when the output is enabled and turning off when the output is disabled.

Parallel setting state Messages	Description
Master	When the PHU is used in parallel, "Master" indicates that this machine is set as the master.

Buzzer setting state Messages	Description
	Key sound : Activates
	Key sound : Deactivates
Detect state Messages**	Description
	None
	Under Voltage Detected (V)
	Over Voltage Detected (V)
	Under Current Detected (A)
	Over Current Detected (A)
	Over Power Detected (W)
Delay output state Messages	Description
	None
	Output ON delay time is set to non-zero values. (This icon will remain displayed until the output is turned on, at which point it will disappear.)
	Output OFF delay time is set to non-zero values. (This icon will remain displayed until the output is turned off, at which point it will disappear.)
Output state Messages	Description
	Output is turned off.
	Output is turned on. (CV status)
	Output is turned on. (CC status)

CP	Output is turned on. (CP status)
OUT	Unknown status or transitioning from CV to CC.

Other Messages	説明
----------------	----

	None
Runing	The Sequence System is running.
CAL	Entering Remote Calibration.
Loading	Loading data into the Sequence System.Fan
	Fan error.
	
Waiting	Waiting for SEQ Trig IN.
Pause	The Sequence System has entered Pause mode. Press the ESC key to resume execution.
Sleep	An AC drop has occurred, and the Sequence System has entered Sleep mode.
Wake	The AC drop has been cleared, and the Sequence System is starting.

Output setting Messages	Description (The values in the image are for reference only.)
-------------------------	---

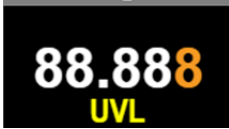
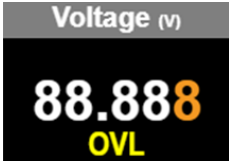
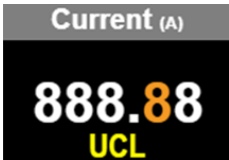
Voltage (V) 	Under voltage limit (the part with yellow text)
Voltage (V) 	Over voltage limit (the part with yellow text)
Current (A) 	Under current limit (the part with yellow text)

<p>Current (A)</p> <p>888.88</p> <p>OCL</p>	<p>Over current limit (the part with yellow text)</p>
<p>Power (W)</p> <p>8888.8</p> <p>OPL</p>	<p>Over power limit (the part with yellow text)</p>
<p>Resistor (Ω)</p> <p>888888</p> <p>ORL</p>	<p>Over resistance limit (the part with yellow text)</p>

* The user can view all protection statuses by pressing the SHIFT key + 9.

** You need to set Action to signal for these prompts to appear.

8-3. PHU Specifications

The specifications apply when the PHU is powered on for at least 30 minutes.

8-3-1. Output

Model	PHU-	502L80	502L200	502M500	502M750	502H1000	502H1500
Rated Output Voltage* ¹ V		80	200	500	750	1000	1500
Rated Output Current* ² A		170	70	30	20	15	10
Rated Output Power W		5000	5000	5000	5000	5000	5000
Output power ratio	-	2.72	2.8	3	3	3	3

Model	PHU-	103L80	103L200	103M500	103M750	103H1000	103H1500
Rated Output Voltage* ¹ V		80	200	500	750	1000	1500
Rated Output Current* ² A		340	140	60	40	30	20
Rated Output Power W		10000	10000	10000	10000	10000	10000
Output power ratio	-	2.72	2.8	3	3	3	3

Model	PHU-	153L80	153L200	153M500	153M750	153H1000	153H1500
Rated Output Voltage* ¹ V		80	200	500	750	1000	1500
Rated Output Current* ² A		510	210	90	60	45	30
Rated Output Power W		15000	15000	15000	15000	15000	15000
Output power ratio	-	2.72	2.8	3	3	3	3

8-3-2. Constant Voltage Mode

Model	PHU-	502L80	502L200	502M500	502M750	502H1000	502H1500	
Line regulation ^{*3} [0.01% of Vo_rated]	mV	8	20	50	75	100	150	
Load regulation ^{*4} [0.02% of Vo_rated]	mV	16	40	100	150	200	300	
Ripple and noise ^{*5}	p-p ^{*6}	mV	200	300	350	800	1600	2400
	r.m.s. ^{*7}	mV	16	40	70	200	350	400
Temperature coefficient	ppm/ °C	100ppm/°C of rated output voltage, after a 30 minute warm-up.						
Remote sense compensation voltage	V	4	10	25	37.5	50	75	
Rise time ^{*8}	Rated load	ms	30	30	30	30	30	30
	No load	ms	30	30	30	30	30	30
Fall time ^{*9}	Rated load	ms	80	80	80	80	80	80
	No load	ms	1000	1000	1000	1200	1000	1200
Transient response time ^{*10}	ms	1.5	1.5	1.5	1.5	1.5	1.5	

Model	PHU-		103L80	103L200	103M500	103M750	103H1000	103H1500
Line regulation ^{*3} [0.01% of Vo_rated]		mV	8	20	50	75	100	150
Load regulation ^{*4} [0.02% of Vo_rated]		mV	16	40	100	150	200	300
Ripple and noise ^{*5}	p-p ^{*6}	mV	200	300	350	800	1600	2400
	r.m.s. ^{*7}	mV	16	40	70	200	350	400
Temperature coefficient		ppm/ °C	100ppm/°C of rated output voltage, after a 30 minute warm-up.					
Remote sense compensation voltage		V	4	10	25	37.5	50	75
Rise time ^{*8}	Rated load	ms	30	30	30	30	30	30
	No load	ms	30	30	30	30	30	30
Fall time ^{*9}	Rated load	ms	80	80	80	80	80	80
	No load	ms	1000	1000	1000	1200	1000	1200
Transient response time ^{*10}		ms	1.5	1.5	1.5	1.5	1.5	1.5

Model	PHU-		153L80	153L200	153M500	153M750	153H1000	153H1500
Line regulation ^{*3} [0.01% of Vo_rated]		mV	8	20	50	75	100	150
Load regulation ^{*4} [0.02% of Vo_rated]		mV	16	40	100	150	200	300
Ripple and noise ^{*5}	p-p ^{*6}	mV	200	300	350	800	1600	2400
	r.m.s. ^{*7}	mV	16	40	70	200	350	400
Temperature coefficient		ppm/ °C 100ppm/°C of rated output voltage, after a 30 minute warm-up.						
Remote sense compensation voltage		V	4	10	25	37.5	50	75
Rise time ^{*8}	Rated load	ms	30	30	30	30	30	30
	No load	ms	30	30	30	30	30	30
Fall time ^{*9}	Rated load	ms	80	80	80	80	80	80
	No load	ms	1000	1000	1000	1200	1000	1200
Transient response time ^{*10}		ms	1.5	1.5	1.5	1.5	1.5	1.5

8-3-3. Constant Current Mode

Model	PHU-		502L80	502L200	502M500	502M750	502H1000	502H1500
Line regulation ^{*3} [0.05% of Io_rated]		mA	85	35	15	10	7.5	5
Load regulation ^{*4} [0.1% of Io_rated]		mA	170	70	30	20	15	10
Ripple and noise ^{*12}	r.m.s. ^{*7}	mA	170	50	16	16	8	8
Temperature coefficient		ppm/ °C 100 ppm/°C of rated output current, after a 30 minute warm-up.						

Model	PHU-	103L80	103L200	103M500	103M750	103H1000	103H1500	
Line regulation ^{*3} [0.05% of lo _{rated}]		mA	170	70	30	20	15	10
Load regulation ^{*4} [0.1% of lo _{rated}]		mA	340	140	60	40	30	20
Ripple and noise ^{*12}	r.m.s. ^{*7}	mA	340	100	32	32	22	22
Temperature coefficient	ppm/ °C Rated Output Voltage の 100ppm/°C 、30 分間のウォームアップ後							

Model	PHU-	153L80	153L200	153M500	153M750	153H1000	153H1500	
Line regulation ^{*3} [0.05% of lo _{rated}]		mA	255	105	45	30	22.5	15
Load regulation ^{*4} [0.1% of lo _{rated}]		mA	510	210	90	60	45	30
Ripple and noise ^{*12}	r.m.s. ^{*7}	mA	510	150	48	48	26	26
Temperature coefficient	ppm/ °C 100 ppm/°C of rated output current, after a 30 minute warm-up.							

8-3-4. Protection Function

Model	PHU-	502L80	502L200	502M500	502M750	502H1000	502H1500	
Over voltage protection (OVP)	Setting range	V	5.00 ~ 88.00	5.00 ~ 220.00	5.00 ~ 550.00	5.0 ~ 825.0	5.0 ~ 1100.0	5.0 ~ 1650.0
	Setting accuracy	mV	80	200	500	750	1000	1500
Over current protection (OCP)	Setting range	A	5.00 ~ 187.00	5.00 ~ 77.00	3.000 ~ 33.000	2.000 ~ 22.000	1.500 ~ 16.500	1.000 ~ 11.000
	Setting accuracy	mA	340	140	60	40	30	20
Over power protection (OPP)	Setting range	W	100 ~ 5500	100 ~ 5500	100 ~ 5500	100 ~ 5500	100 ~ 5500	100 ~ 5500
	Setting accuracy	W	50	50	50	50	50	50
Over voltage limit(OVL)	Setting range	V	0.00 ~ 84.00	0.00 ~ 210.00	0.00 ~ 525.00	0.0 ~ 787.5	0.0 ~ 1050.0	0.0 ~ 1575.0
Under voltage limit (UVL)	Setting range	V	0.00 ~ 84.00	0.00 ~ 210.00	0.00 ~ 525.00	0.0 ~ 787.5	0.0 ~ 1050.0	0.0 ~ 1575.0
Over current limit (OCL)	Setting range	A	0.00 ~ 178.50	0.00 ~ 73.50	0.000 ~ 31.500	0.000 ~ 21.000	0.000 ~ 15.750	0.000 ~ 10.500
Under current limit (UCL)	Setting range	A	0.00 ~ 178.50	0.00 ~ 73.50	0.000 ~ 31.500	0.000 ~ 21.000	0.000 ~ 15.750	0.000 ~ 10.500

Model	PHU-	103L80	103L200	103M500	103M750	103H1000	103H1500	
Over voltage protection (OVP)	Setting range	V	5.00 ~ 88.00	5.00 ~ 220.00	5.00 ~ 550.00	5.0 ~ 825.0	5.0 ~ 1100.0	5.0 ~ 1650.0
	Setting accuracy	mV	80	200	500	750	1000	1500
Over current protection (OCP)	Setting range	A	5.00 ~ 374.00	5.00 ~ 154.00	5.00 ~ 66.00	4.000 ~ 44.000	3.000 ~ 33.000	2.000 ~ 22.000
	Setting accuracy	mA	680	280	120	80	60	40
Over power protection (OPP)	Setting range	W	200 ~ 11000	200 ~ 11000	200 ~ 11000	200 ~ 11000	200 ~ 11000	200 ~ 11000
	Setting accuracy	W	100	100	100	100	100	100
Over voltage limit(OVL)	Setting range	V	0.00 ~ 84.00	0.00 ~ 210.00	0.00 ~ 525.00	0.0 ~ 787.5	0.0 ~ 1050.0	0.0 ~ 1575.0
Under voltage lim (UL)	Setting range	V	0.00 ~ 84.00	0.00 ~ 210.00	0.00 ~ 525.00	0.0 ~ 787.5	0.0 ~ 1050.0	0.0 ~ 1575.0
Over current limit (OCL)	Setting range	A	0.00 ~ 357.00	0.00 ~ 147.00	0.00 ~ 63.00	0.000 ~ 42.000	0.000 ~ 31.500	0.000 ~ 21.000
Under current limit (UCL)	Setting range	A	0.00 ~ 357.00	0.00 ~ 147.00	0.00 ~ 63.00	0.000 ~ 42.000	0.000 ~ 31.500	0.000 ~ 21.000
Model	PHU-	153L80	153L200	153M500	153M750	153H1000	153H1500	
Over voltage protection (OVP)	Setting range	V	5.00 ~ 88.00	5.00 ~ 220.00	5.00 ~ 550.00	5.0 ~ 825.0	5.0 ~ 1100.0	5.0 ~ 1650.0
	Setting accuracy	mV	80	200	500	750	1000	1500
Over current protection (OCP)	Setting range	A	5.00 ~ 561.00	5.00 ~ 231.00	5.00 ~ 99.00	5.00 ~ 66.00	4.5 ~ 49.500	3 ~ 33.000
	Setting accuracy	mA	1020	420	180	120	90	60
Over power protection (OPP)	Setting range	W	300 ~ 16500	300 ~ 16500	300 ~ 16500	300 ~ 16500	300 ~ 16500	300 ~ 16500
	Setting accuracy	W	150	150	150	150	150	150
Over voltage limit(OVL)	Setting range	V	0.00 ~ 84.00	0.00 ~ 210.00	0.00 ~ 525.00	0.0 ~ 787.5	0.0 ~ 1050.0	0.0 ~ 1575.0
Under voltage lim (UL)	Setting range	V	0.00 ~ 84.00	0.00 ~ 210.00	0.00 ~ 525.00	0.0 ~ 787.5	0.0 ~ 1050.0	0.0 ~ 1575.0
Over current limit (OCL)	Setting range	A	0.00 ~ 535.50	0.00 ~ 220.50	0.00 ~ 94.50	0.00 ~ 63.00	0.000 ~ 47.250	0.000 ~ 31.500
Under current limit (UCL)	Setting range	A	0.00 ~ 535.50	0.00 ~ 220.50	0.00 ~ 94.50	0.00 ~ 63.00	0.000 ~ 47.250	0.000 ~ 31.500

Model	PHU	
Power unit fail (PUF)	Operation	Turn the output off.
Incorrect sensing connection protection (SENSE)	Operation	Turn the output off.
Low AC input protection (AC-FAIL)	Operation	Turn the output off.
Shutdown (SD)	Operation	Turn the output off.
Power limit (POWER LIMIT)	Operation	Over power limit.
	Value (fixed)	Approx. 102% of rated output power

8-3-5. Other Function

Model	PHU-		502L80	502L200	502M500	502M750	502H1000	502H1500
Voltage Slew Rate	Setting range	V/s	0.01 ~ 160.00	0.01 ~ 400.00	0.1 ~ 1000.0	0.1 ~ 1500.0	0.1 ~ 2000.0	0.1 ~ 3000.0
	Resolution	mV	10	10	100	100	100	100
Current slew rate	Setting range	A/s	0.01 ~ 340.00	0.01 ~ 140.00	0.001 ~ 60.000	0.001 ~ 40.000	0.001 ~ 30.000	0.001 ~ 20.000
	Resolution	mA	10	10	1	1	1	1
Internal resistance	Setting range	Ω	0.000 ~ 0.471	0.000 ~ 2.857	0.00 ~ 16.67	0.00 ~ 37.50	0.0 ~ 66.7	0.0 ~ 150.0
	Resolution	m Ω	1	1	10	10	100	100

Model	PHU-		103L80	103L200	103M500	103M750	103H1000	103H1500
Voltage Slew Rate	Setting range	V/s	0.01 ~ 160.00	0.01 ~ 400.00	0.1 ~ 1000.0	0.1 ~ 1500.0	0.1 ~ 2000.0	0.1 ~ 3000.0
	Resolution	mV	10	10	100	100	100	100
Current slew rate	Setting range	A/s	0.1 ~ 680.0	0.01 ~ 280.00	0.01 ~ 120.00	0.01 ~ 80.00	0.001 ~ 60.000	0.001 ~ 40.000
	Resolution	mA	100	10	10	10	1	1
Internal resistance	Setting range	Ω	0.000 ~ 0.235	0.000 ~ 1.428	0.00 ~ 8.33	0.00 ~ 18.75	0.00 ~ 33.33	0.0 ~ 75.0
	Resolution	m Ω	1	1	10	10	10	100

Model	PHU-		153L80	153L200	153M500	153M750	153H1000	153H1500
Voltage Slew Rate	Setting range	V/s	0.01 ~ 160.00	0.01 ~ 400.00	0.1 ~ 1000.0	0.1 ~ 1500.0	0.1 ~ 2000.0	0.1 ~ 3000.0
	Resolution	mV	10	10	100	100	100	100
Current slew rate	Setting range	A/s	0.1 ~ 1020.0	0.01 ~ 420.00	0.01 ~ 180.00	0.01 ~ 120.00	0.01 ~ 90.00	0.001 ~ 60.000
	Resolution	mA	100	10	10	10	10	1
Internal resistance	Setting range	Ω	0.000 ~ 0.157	0.00 ~ 0.95	0.00 ~ 5.56	0.00 ~ 12.50	0.00 ~ 22.22	0.0 ~ 50.0
	Resolution	m Ω	1	10	10	10	10	100

8-3-6. Front Panel

Model	PHU-	502L80	502L200	502M500	502M750	502H1000	502H1500
Display	TFT-LCD, 5", 800pt x 480pt						
Voltage accuracy [0.1% of Vo_rated]	mV	80	200	500	750	1000	1500
Current accuracy [0.2% of Io_rated]	mA	340	140	60	40	30	20
Power accuracy [1% of Po_rated]	W	50	50	50	50	50	50
Voltage resolution	V	0.01	0.01	0.01	0.1	0.1	0.1
Current resolution	A	0.01	0.01	0.001	0.001	0.001	0.001
Power resolution	W	0.1	0.1	0.1	0.1	0.1	0.1

Model	PHU-	103L80	103L200	103M500	103M750	103H1000	103H1500
Display	TFT-LCD, 5", 800pt x 480pt						
Voltage accuracy [0.1% of Vo_rated]	mV	80	200	500	750	1000	1500
Current accuracy [0.2% of Io_rated]	mA	680	280	120	80	60	40
Power accuracy [1% of Po_rated]	W	100	100	100	100	100	100
Voltage resolution	V	0.01	0.01	0.01	0.1	0.1	0.1
Current resolution	A	0.01	0.01	0.001	0.001	0.001	0.001
Power resolution	W	1	1	1	1	1	1

Model	PHU-	153L80	153L200	153M500	153M750	153H1000	153H1500
Display	TFT-LCD, 5", 800pt x 480pt						
Voltage accuracy [0.1% of Vo_rated]	mV	80	200	500	750	1000	1500
Current accuracy [0.2% of Io_rated]	mA	1020	420	180	120	90	60
Power accuracy [1% of Po_rated]	W	150	150	150	150	150	150
Voltage resolution	V	0.01	0.01	0.01	0.1	0.1	0.1
Current resolution	A	0.01	0.01	0.01	0.001	0.001	0.001
Power resolution	W	1	1	1	1	1	1

Model	PHU
Buttons	Menu, Local, Exit, Clear, Enter, Lock, Current, Shift Output, Numeric Keypad
Rotary knob	Turn the knob to increase or decrease the value.
USB port	Type A USB connector

8-3-7. Programming and Measurement (Digital Interface)

Model	PHU-	502L80	502L200	502M500	502M750	502H1000	502H1500
Output voltage programming range	0 to 105% V	0 ~ 84	0 ~ 210	0 ~ 525	0 ~ 787.5	0 ~ 1050	0 ~ 1575
Output current programming range	0 to 105% A	0 ~ 178.5	0 ~ 73.5	0 ~ 31.5	0 ~ 21	0 ~ 15.75	0 ~ 10.5
Output power programming range	0 to 102% W	0 ~ 5100	0 ~ 5100	0 ~ 5100	0 ~ 5100	0 ~ 5100	0 ~ 5100
Output voltage programming accuracy [0.1% of Vo_rated]	mV	80	200	500	750	1000	1500
Output current programming accuracy [0.2% of Io_rated]	mA	340	140	60	40	30	20
Output power programming accuracy [1% of Po_rated]	W	50	50	50	50	50	50
Output voltage programming resolution	mV	10	10	10	100	100	100
Output current programming resolution	mA	10	10	1	1	1	1
Output power programming resolution	W	0.1	0.1	0.1	0.1	0.1	0.1
Output voltage measurement accuracy [0.1% of Vo_rated]	mV	80	200	500	750	1000	1500
Output current measurement accuracy [0.2% of Io_rated]	mA	340	140	60	40	30	20
Output power measurement accuracy [1% of Po_rated]	W	50	50	50	50	50	50
Output voltage measurement resolution	mV	10	10	10	100	100	100
Output current measurement resolution	mA	10	10	1	1	1	1
Output power measurement resolution	W	0.1	0.1	0.1	0.1	0.1	0.1

Model	PHU-	103L80	103L200	103M500	103M750	103H1000	103H1500
Output voltage programming range	0 to 105% V	0 ~ 84	0 ~ 210	0 ~ 525	0 ~ 787.5	0 ~ 1050	0 ~ 1575
Output current programming range	0 to 105% A	0 ~ 357	0 ~ 147	0 ~ 63	0 ~ 42	0 ~ 31.5	0 ~ 21
Output power programming range	0 to 102% W	0 ~ 10200	0 ~ 10200	0 ~ 10200	0 ~ 10200	0 ~ 10200	0 ~ 10200
Output voltage programming accuracy [0.1% of Vo_rated]	mV	80	200	500	750	1000	1500
Output current programming accuracy [0.2% of Io_rated]	mA	680	280	120	80	60	40
Output power programming accuracy [1% of Po_rated]	W	100	100	100	100	100	100
Output voltage programming resolution	mV	10	10	10	100	100	100
Output current programming resolution	mA	10	10	1	1	1	1
Output power programming resolution	W	1	1	1	1	1	1
Output voltage measurement accuracy [0.1% of Vo_rated]	mV	80	200	500	750	1000	1500
Output current measurement accuracy [0.2% of Io_rated]	mA	680	280	120	80	60	40
Output power measurement accuracy [1% of Po_rated]	W	100	100	100	100	100	100
Output voltage measurement resolution	mV	10	10	10	100	100	100
Output current measurement resolution	mA	10	10	1	1	1	1
Output power measurement resolution	W	1	1	1	1	1	1

Model	PHU-	153L80	153L200	153M500	153M750	153H1000	153H1500
Output voltage programming range	0 to 105% V	0 ~ 84	0 ~ 210	0 ~ 525	0 ~ 787.5	0 ~ 1050	0 ~ 1575
Output current programming range	0 to 105% A	0 ~ 535.5	0 ~ 220.5	0 ~ 94.5	0 ~ 63	0 ~ 47.25	0 ~ 31.5
Output power programming range	0 to 102% W	0 ~ 15300	0 ~ 15300	0 ~ 15300	0 ~ 15300	0 ~ 15300	0 ~ 15300
Output voltage programming accuracy [0.1% of Vo_rated]	mV	80	200	500	750	1000	1500
Output current programming accuracy [0.2% of Io_rated]	mA	1020	420	180	120	90	60
Output power programming accuracy [1% of Po_rated]	W	150	150	150	150	150	150
Output voltage programming resolution	mV	10	10	10	100	100	100
Output current programming resolution	mA	10	10	10	1	1	1
Output power programming resolution	W	1	1	1	1	1	1
Output voltage measurement accuracy [0.1% of Vo_rated]	mV	80	200	500	750	1000	1500
Output current measurement accuracy [0.2% of Io_rated]	mA	1020	420	180	120	90	60
Output power measurement accuracy [1% of Po_rated]	W	150	150	150	150	150	150
Output voltage measurement resolution	mV	10	10	10	100	100	100
Output current measurement resolution	mA	10	10	10	1	1	1
Output power measurement resolution	W	1	1	1	1	1	1

8-3-8. Input Characteristics for PHU-B series (for 5kW models)

Model	PHU-B models		
Nominal input rating	1-Phase, 200 V models: 180 Vac to 265 Vac (Covers 200/ 208/230/240 Vac)		
Input frequency range	47 Hz to 63 Hz		
Maximum input current	200Vac	A	32 A
Inrush current	200Vac	A	Less than 50 A
Maximum input power		VA	6000
Power factor	Rated Power		> 0.95
Efficiency ^{*14}	200 Vac	%	86 to 94
Hold-up time	10 ms or greater		

8-3-9. Input Characteristics for PHU-B series (for 10kW models)

Model	PHU-B models		
Nominal input rating	1-Phase, 200 V models: 180 Vac to 265 Vac (Covers 200/ 208/230/240 Vac)		
Input frequency range	47 Hz to 63 Hz		
Maximum input current	200Vac	A	64 A
Inrush current	200Vac	A	Less than 100 A
Maximum input power		VA	12000
Power factor	Rated Power		> 0.95
Efficiency ^{*14}	200 Vac	%	86 to 94
Hold-up time	10 ms or greater		

8-3-10. Input Characteristics for PHU-C series (for 5kW models)

Model	PHU-C Model		
Nominal input rating	3-Phase, 200 V models: 180 Vac to 265 Vac (Covers 200/ 230 Vac)		
Input frequency range	47 Hz to 63 Hz		
Maximum input current	200Vac	A	32 A (L1, L2)
Inrush current	200Vac	A	Less than 50 A
Maximum input power		VA	6000
Power factor	Rated Power		> 0.95
Efficiency ^{*14}	200 Vac	%	86 to 94
Hold-up time	10 ms or greater		

8-3-11. Input Characteristics for PHU-C series (for 10kW models)

Model	PHU-C Model		
Nominal input rating	3-Phase, 200 V models: 180 Vac to 265 Vac (Covers 200/ 230 Vac)		
Input frequency range	47 Hz to 63 Hz		
Maximum input current	200Vac	A	56 A (L1), 32 A (L2, L3)
Inrush current	200Vac	A	Less than 100 A
Maximum input power		VA	12000
Power factor	Rated Power		> 0.95
Efficiency ^{*14}	200 Vac	%	86 to 94
Hold-up time	10 ms or greater		

8-3-12. Input Characteristics for PHU-C series (for 15kW models)

Model	PHU-C Model		
Nominal input rating	3-Phase, 200 V models: 180 Vac to 265 Vac (Covers 200/ 230 Vac)		
Input frequency range	47 Hz to 63 Hz		
Maximum input current	200Vac	A	56 A (L1, L2, L3)
Inrush current	200Vac	A	Less than 100 A
Maximum input power		VA	18000
Power factor	Rated Power		> 0.95
Efficiency ^{*14}	200 Vac	%	86 to 94
Hold-up time	10 ms or greater		

8-3-13. Input Characteristics for PHU-D series (for 5kW models)

Model	PHU-D Model		
Nominal input rating	3-Phase, 400 V models: 342 Vac to 528 Vac (Covers 380/400/415/440/460/480 Vac)		
Input frequency range	47 Hz to 63 Hz		
Maximum input current	400Vac	A	16 A (L1, L2)
Inrush current	400Vac	A	Less than 25 A
Maximum input power		VA	6000
Power factor	Rated Power		> 0.95
Efficiency ^{*14}	400 Vac	%	87 to 94
Hold-up time	10 ms or greater		

8-3-14. Input Characteristics for PHU-D series (for 10kW models)

Model	PHU-D Model		
Nominal input rating	3-Phase, 400 V models: 342 Vac to 528 Vac (Covers 380/400/415/440/460/480 Vac)		
Input frequency range	47 Hz to 63 Hz		
Maximum input current	400Vac	A	28 A (L1), 16 A (L2, L3)
Inrush current	400Vac	A	Less than 50 A
Maximum input power		VA	12000
Power factor	Rated Power		> 0.95
Efficiency ^{*14}	400 Vac	%	87 to 94
Hold-up time	10 ms or greater		

8-3-15. Input Characteristics for PHU-D series (for 15kW models)

Model	PHU-D Model		
Nominal input rating	3-Phase, 400 V models: 342 Vac to 528 Vac (Covers 380/400/415/440/460/480 Vac)		
Input frequency range	47 Hz to 63 Hz		
Maximum input current	400Vac	A	28 A (L1, L2, L3)
Inrush current	400Vac	A	Less than 50 A
Maximum input power		VA	18000
Power factor	Rated Power		> 0.95
Efficiency ^{*14}	400 Vac	%	87 to 94
Hold-up time	10 ms or greater		

8-3-16. Interface Capabilities

Model	PHU
USB	Type A: Host, Type B: Slave, Speed: 1.1/2.0, USB Class: CDC (Communications Device Class)
LAN	MAC Address, DNS IP Address, User Password, Gateway IP Address, Instrument IP Address, Subnet Mask TCP-Socket, HTTP
Isolated Analog Control Interface	Vset/ Iset = 0 V to 5 V or 0 V to 10 V Vmon/ Imon = 0 V to 5 V or 0 V to 10 V
Factory Optional	RS-232C: EIA/TIA-232D RS-485:EIA-485 GP-IB:IEE488.1

8-3-17. Isolated Analog Control Interface

Model	PHU
Vout voltage programming	0 to 100%, 0 V to 5 V Accuracy: $\pm 1\%$ of rated Vout, or 0~10 V Accuracy: $\pm 1\%$ of rated Vout
Iout voltage programming	0 to 100%, 0 V to 5 V Accuracy: $\pm 1\%$ of rated Iout, or 0 V to 10 V Accuracy: $\pm 1\%$ of rated Iout
Pout voltage programming	0 to 100%, 0 V to 5 V Accuracy: $\pm 1\%$ of rated Pout, or 0 V to 10 V Accuracy: $\pm 1\%$ of rated Pout
Internal resistance voltage programming	0 to 100%, 0 V to 5 V Accuracy: $\pm 1\%$ of maximum Rint, or 0 V to 10 V Accuracy: $\pm 1\%$ of maximum Rint
Output voltage monitor	0 V to 5 V or 0 V to 10 V, Accuracy: $\pm 1\%$.
Output current monitor	0 to 5 V or 0 to 10 V, Accuracy: $\pm 1\%$.
Reference voltage	Voltage reference for 0 V to 5 V or 0 V to 10 V.
Alarm Input	Turn off the PHU output with a High (4.5 V to 5 V)
Output on/off control	<ul style="list-style-type: none"> Possible logic selections: Turn the output on using a LOW (0 V to 0.5 V) or short-circuit, turn the output off using a HIGH (4.5 V to 5 V) or open-circuit. Turn the output on using a HIGH (4.5 V to 5 V) or open-circuit, turn the output off using a LOW (0 V to 0.5 V) or short-circuit.
Alarm clear control	Clear alarms with a High (4.5V to 5V)
CV/ CC/ CP/ ALM/ PWR ON/ OUT ON indicator	Photocoupler open collector output; Maximum voltage 30 V, maximum sink current 8 mA.

8-3-18. Environment Conditions

Model	PHU
Operating temperature	0°C to 50°C
Storage temperature	-25°C to 70°C
Operating humidity	20% to 85% RH; No condensation
Storage humidity	90% RH or less; No condensation
Altitude	Maximum 2000m

8-3-19. General Specifications

Model	PHU-	5kW Model	10kW Model	15kW Model
Weight	main unit only	Less than 21 kg	Less than 30.5 kg	Less than 40 kg

Model	PHU
Dimensions (W×H×D) mm	442 × 130 × 675
Cooling	Forced air cooling by internal fan
EMC	Complies with the European EMC EN61326-1(ClassA),EMC 2014/30/EU.
Safety	Complies with the European Low Voltage Directive EN61010-1(Class1, Pollution degree2),2014/35/EU.
Withstand voltage	Chassis and output terminal; chassis and AC input; AC input and output terminal: AC 1500 V or DC 2130 V 1 minute
Insulation resistance	Chassis and output terminal; chassis and AC input; AC input and output terminal: 100 MΩ or more (DC 500 V)

Notes:

- *1 Minimum voltage is guaranteed to maximum 0.2% of the rated output voltage.
- *2 Minimum current is guaranteed to maximum 0.4% of the rated output current.
- *3 At 180 Vac to 265 Vac or 342 Vac to 528 Vac, constant load.
- *4 From No-load to Full-load, constant input voltage. Measured at the sensing point in Remote Sense.
- *5 For 80 V, 200 V models: Measure with JEITA RC-9131B (1:1) probe. For 500 V, 750 V, 1000 V and 1500 V models: Measured with (100:1) probe
- *6 Measurement frequency bandwidth is 10Hz to 20MHz.
- *7 Measurement frequency bandwidth is 5Hz to 1MHz.
- *8 From 10% to 90% of rated output voltage, with rated resistive load.
- *9 From 90% to 10% of rated output voltage, with rated resistive load.
- *10 Time for output voltage to recover within 1% of its rated output for a load change from 10 to 90% of its rated output current. Voltage set point from 10% to 100% of rated output.
- *11 For load voltage change, equal to the unit voltage rating, constant input voltage.
- *12 The ripple is measured at 20% to 100% output voltage and full output current.
- *13 For output power change from 10% to 90%, constant input voltage.
- *14 At rated output power.

8-4. PHU Dimensions

8-4-1. PHU-M,H

Scale =mm

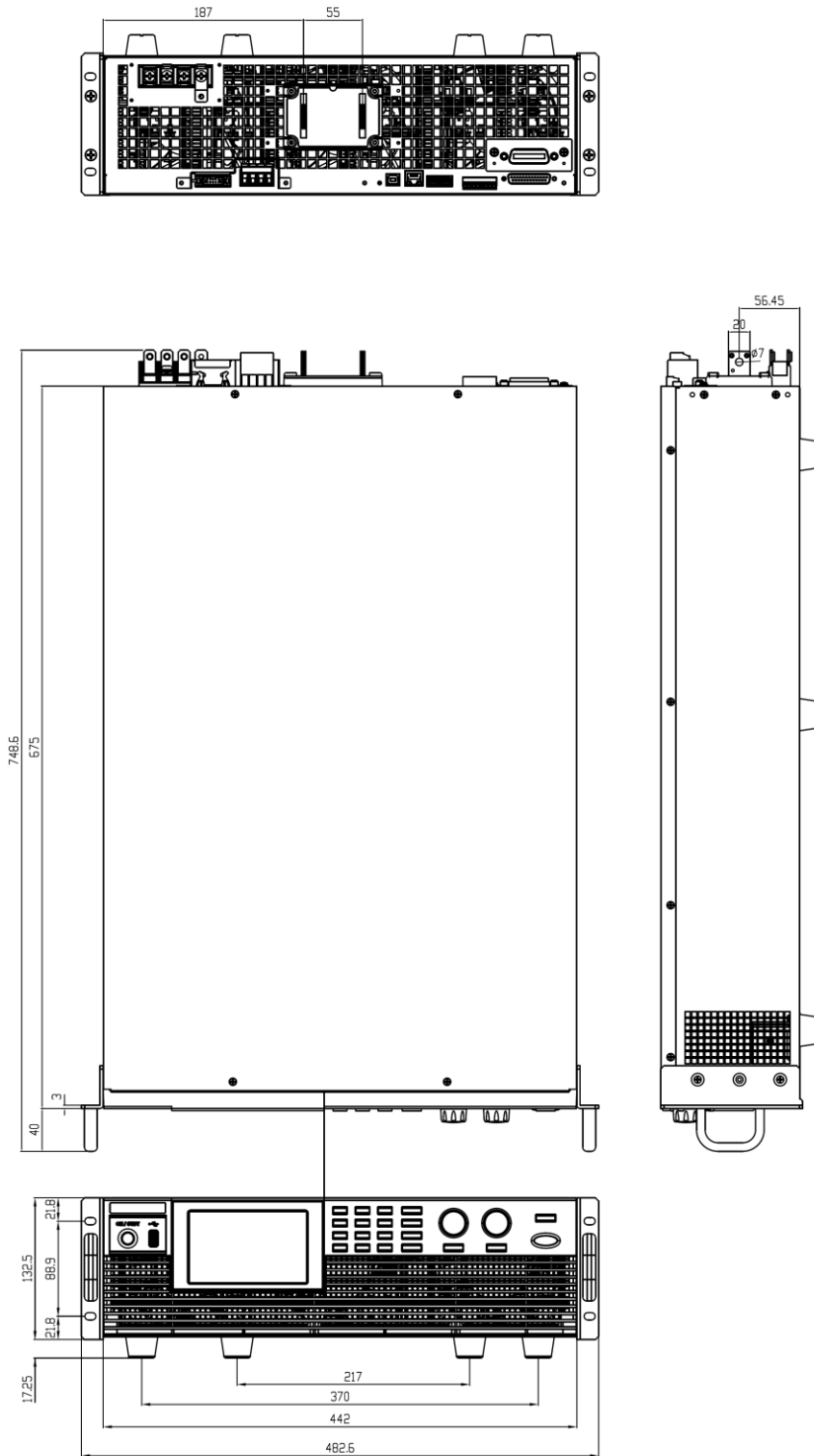

8-4-2. PHU-L

Scale=mm

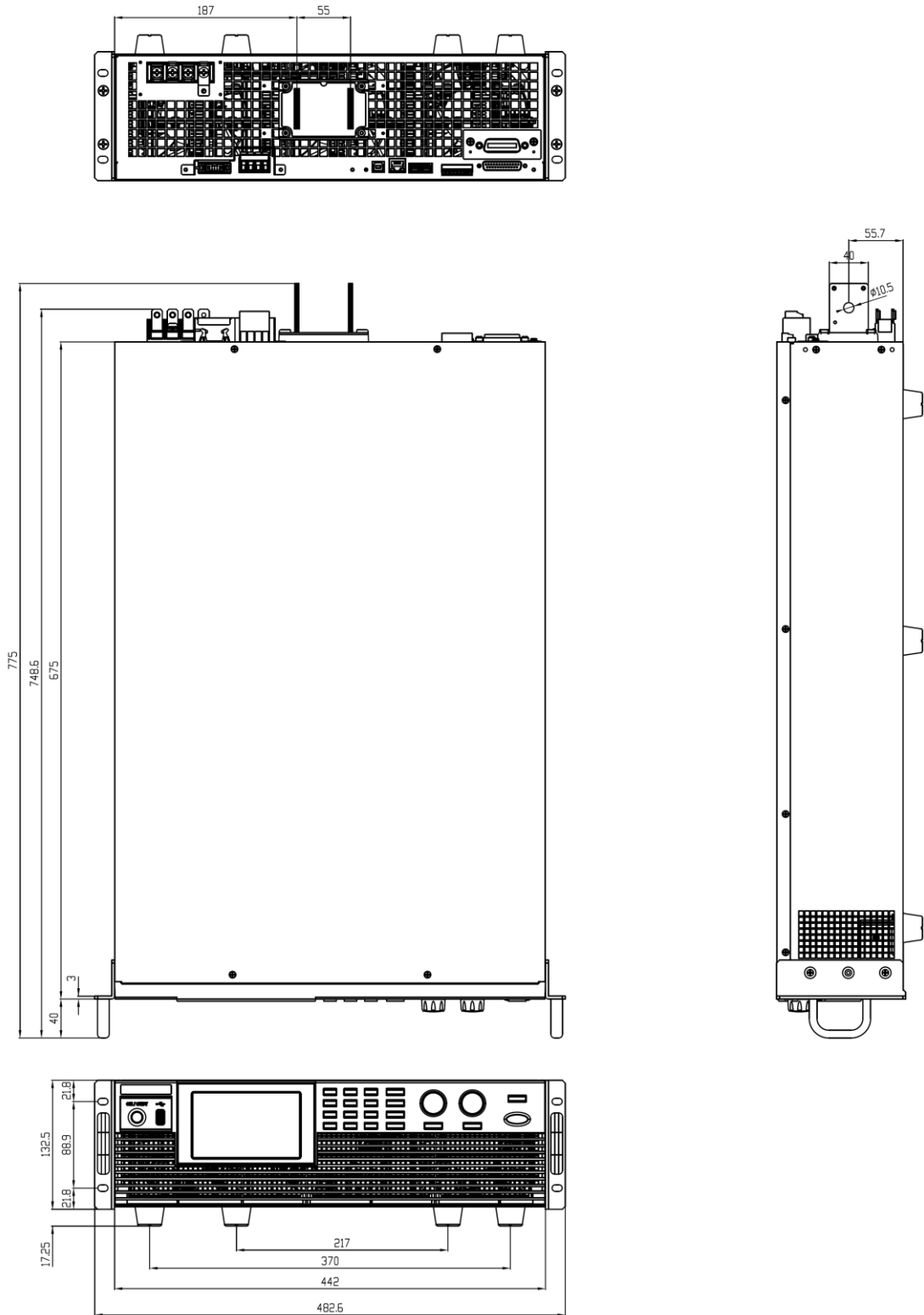



TEXIO TECHNOLOGY CORPORATION

7F Towa Fudosan Shin Yokohama Bldg.

2-18-13, Shin Yokohama, Kohoku-ku, Yokohama, Kanagawa, 222-0033 Japan

<https://www.texio.co.jp/>
